

# Owner's Manual

'Regular'

'Long'

and

Forward Control



By Appointment to  
Her Majesty  
Queen Elizabeth II

Manufacturers  
of Motor Cars  
and Land-Rovers

The Rover Company Limited

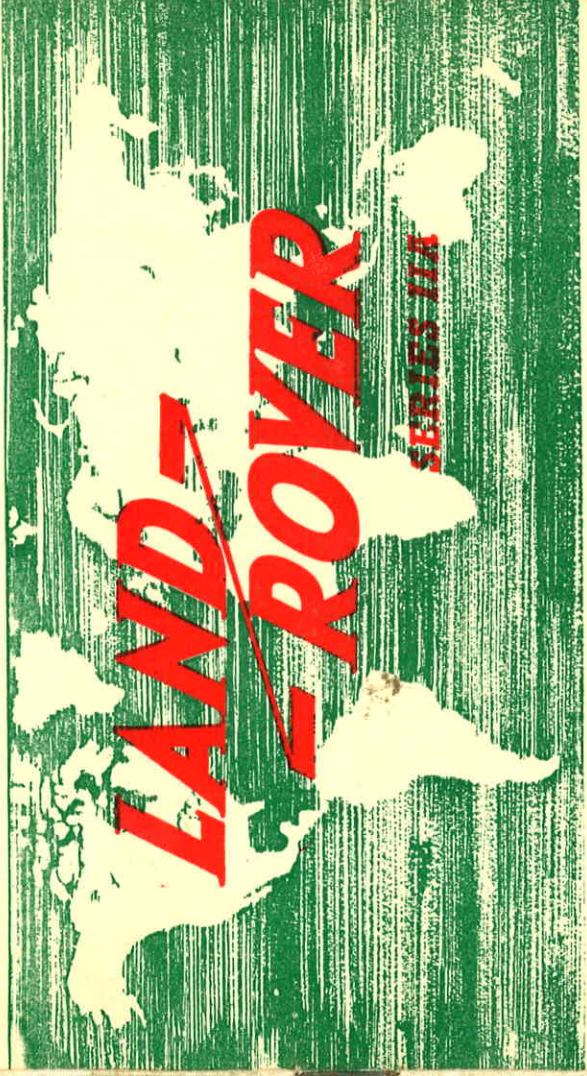

PART No. 4482

**LAND-ROVER**

SERIES IIA

'REGULAR', 'LONG'  
AND  
FORWARD CONTROL

# Owner's Manual

By Appointment to  
Her Majesty  
Queen Elizabeth II



Manufacturers  
of Motor Cars and  
Land-Rovers

By Appointment to  
Her Majesty  
Queen Elizabeth  
the Queen Mother



Suppliers of  
Motor Cars and  
Land-Rovers

**THE ROVER COMPANY LTD**

SOLIHULL  
WARWICKSHIRE  
ENGLAND

Publication No.  
TP/317/H

OCTOBER 1962  
Seventh revision OCTOBER 1965

Part No.  
4482



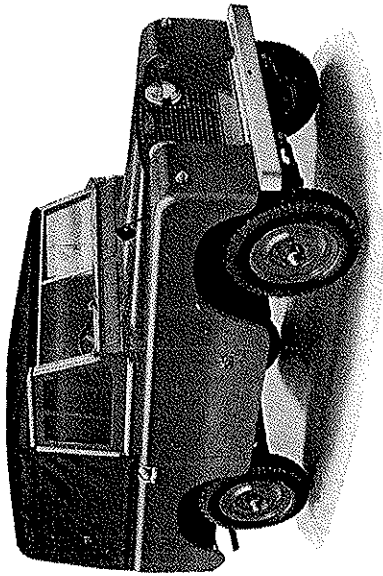

LAND-ROVER SERIES IIA 88 'REGULAR' MODEL

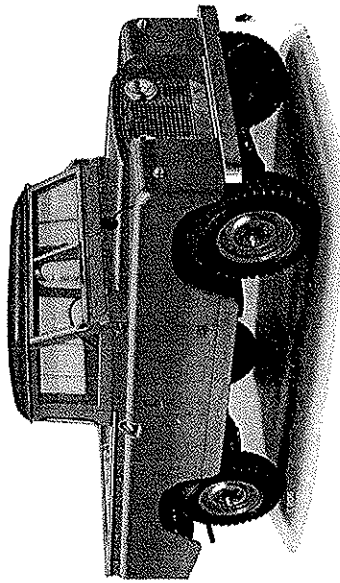

LAND-ROVER SERIES IIA 109 'LONG' MODEL

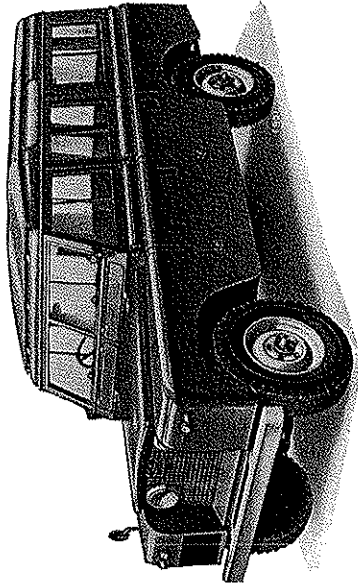

LAND-ROVER SERIES IIA 109 'STATION WAGON'

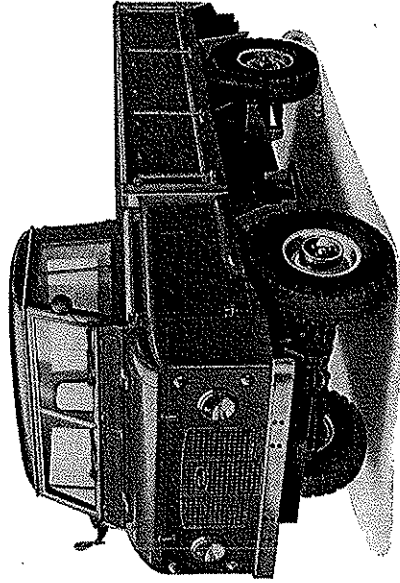

LAND-ROVER SERIES IIA 109 FORWARD CONTROL

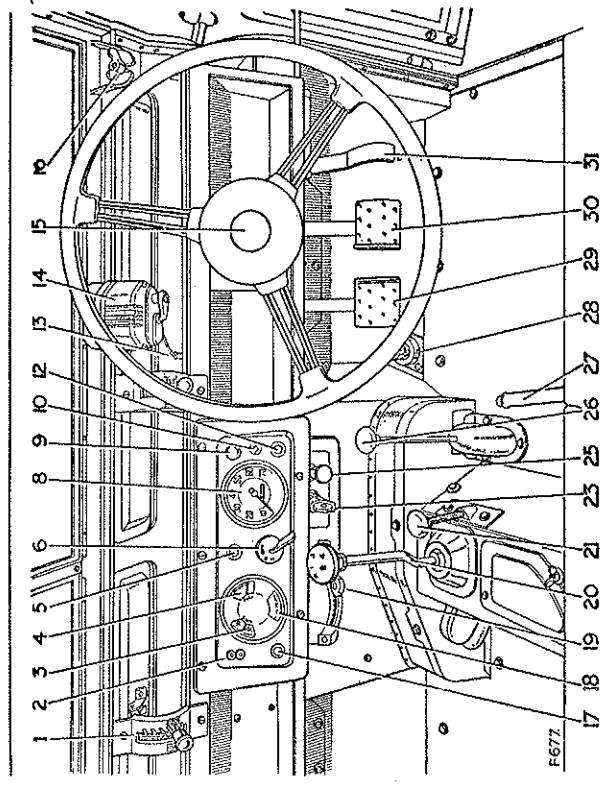

Layout of controls and instruments, 'Regular' and 'Long' Diesel models

- 1 Windscreen ventilators
- 1a Interior light switch (optional)
- 2 Lead lamp socket
- 3 Ammeter
- 4 Fuel level gauge
- 5 Oil pressure warning light
- 6 Lamp switch
- 7 { (Petrol) Ignition switch
- (Early Diesel) Electrical services switch
- 8 Speedometer
- 9 Panel light switch
- 10 { (Diesel) Fuel tank warning light
- (Forward Control) Starter switch
- 11 Cold start control warning light
- 12 Heater plug warning light
- 13 Wiper lead plug
- 14 Windscreen wiper
- 15 Horn button
- 16 Wingnut securing windscreen
- 17 Charging warning light
- 18 Headlamp warning light
- 19 Engine hand speed control
- 20 Main gear change lever
- 21 Front-wheel drive control
- 22 Cold start control
- 23 Starter, heater plug and electrical services switch
- 24 Starter switch
- 25 Engine stop control
- 26 Transfer box lever
- 27 Hand brake
- 28 Headlamp dipper switch
- 29 Clutch pedal
- 30 Brake pedal
- 31 Accelerator pedal
- 32 Flashers switch (Standard equipment Forward Control)

For details of the operation of the instruments and controls see following pages

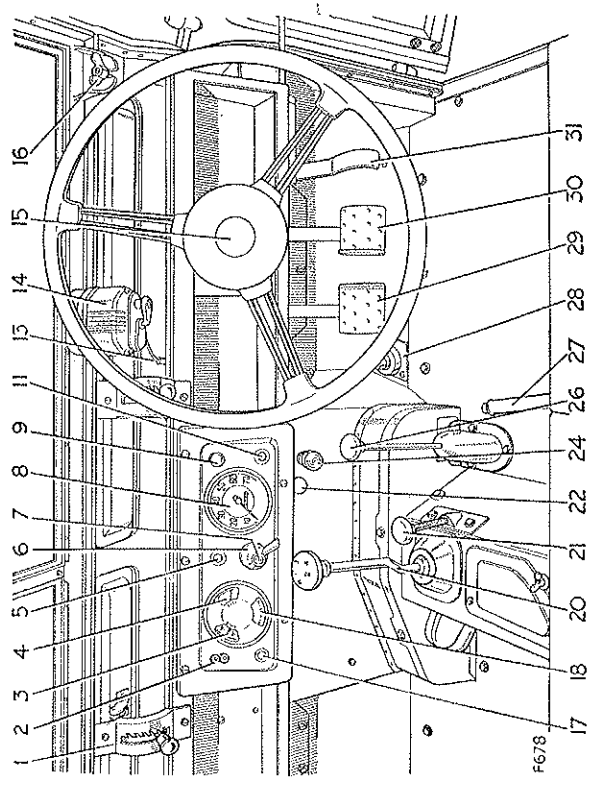

Layout of controls and instruments, 'Regular' and 'Long' Petrol models

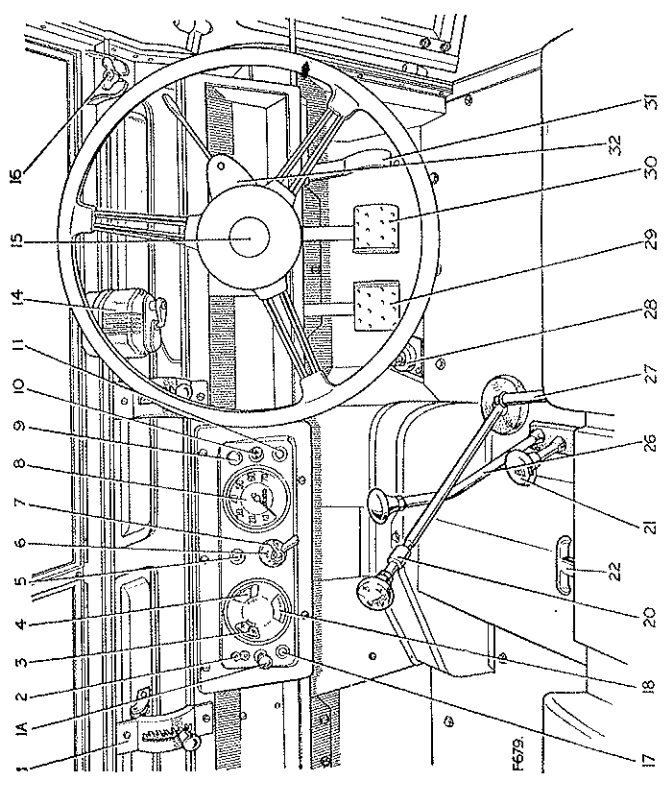

Layout of controls and instruments, Forward Control Petrol models

CONTENTS

	Page
Introduction	7
<b>PART ONE—OPERATING INSTRUCTIONS</b>	
Body fittings	32
Free Service inspection	31
Frost precautions	35
Gear change levers	21
Head, side and tail lamps	19
Instruments and controls	10
Running-in period	30
Starting procedure	27
<b>PART TWO—ROUTINE MAINTENANCE AND ADJUSTMENTS</b>	
Air cleaner maintenance	47
Brake adjustment	74
Brake fluid level	73
Carburettor maintenance	52
Carburettor slow running adjustment, Petrol models	53
Circuit diagrams	84
Clutch mechanism	60
Differential lubrication	70
Distributor maintenance, Petrol models	55
Electrical, battery and fuse box	68
Engine lubrication	43
Fan belt adjustment	57
Flywheel markings	51
Fuel and injection system, Diesel models	64
Fuel system, Petrol models	63
Gearbox lubrication	58
Headlamp beam setting	79
Ignition timing	56
Maintenance and lubrication	37
Maintenance schedule chart	90
Optional equipment requiring maintenance	78
Propeller shafts	39
Recommended lubricants	48
Spark plug and injectors	71
Steering lubrication	50
Tappet adjustment	77
Tyre pressures	77
Tyres and wheels	77
	Pull-out sheet
<b>PART THREE</b>	
In case of trouble	102
<b>PART FOUR</b>	
General data	113
Index	124

INTRODUCTION

This book, together with the Maintenance Schedule Book, has been prepared to present as clearly as possible to you, all the information necessary for the efficient care and maintenance of your Land-Rover. It covers both the Petrol and Diesel models. The paragraphs in this book are therefore applicable to both models, unless otherwise stated in the sub-headings.

Careful running-in of your vehicle is of great importance; high speeds and harsh driving for the first 500 miles can cause unnecessary wear in the engine and transmission and so shorten the life of the Land-Rover.

Although the instructions have been made as simple and clear as possible, there may be occasions when further information is required; in cases such as this you are advised to see your local Rover distributor or dealer, or, if necessary, you can write direct to our Service Department.

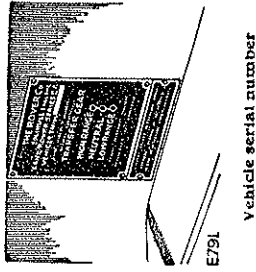

Vehicle serial number

The vehicle serial number will be found on the transfer box instruction plate on the dash panel.

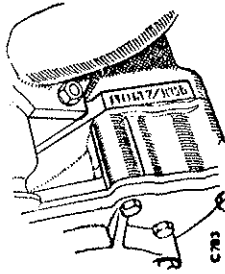

Engine serial number

The full vehicle serial number must be quoted in all correspondence; the registration number of the vehicle is of no use whatever to us.

The engine serial number, which need not be quoted in correspondence, unless specifically asked for, is stamped on the left-hand side of the cylinder block at the front.

Door key number, vehicles with private locks. For security reasons the key number is not stamped on the barrel locks, but will be found stamped on the plate adjacent to the bonnet lock.

We feel it important that you should recognise the importance of using only genuine Rover Parts or Rover Approved Parts when repair or maintenance work is being carried out on your Land-Rover.

Rover parts are produced to the same high standard as those parts built into the Land-Rover in its original production and it is in your best interests that you should insist that only genuine Rover Parts or Rover Approved Parts are fitted to your Land Rover.

It will be realised that from time to time alterations in design and in the make of various accessories occur and this Instruction manual, while being kept up-to-date as far as possible, is not to be taken as a standard specification. The specification may be altered at any time, without incurring any obligation to incorporate such alteration in vehicles already delivered.

For ease of reference the book has been divided into four parts.

Part One gives all the information needed about handling your Land-Rover.

In Part Two will be found full details of the lubrication and maintenance needed, for those owners who intend to carry out this work themselves. If you do not wish to service the Land-Rover yourself we strongly advise that you consult your nearest Rover distributor or dealer and arrange a regular maintenance schedule with him.

Part Three gives the procedure for a systematic examination to locate and remedy the causes of some of the faults which may occur.

Part Four covers the specification of your Land-Rover and also includes a general index to the whole of the book.

Full details of optional equipment available for the Land-Rover are given in a separate publication, "Land-Rover Optional Equipment", Part No. 4437, obtainable free of charge from our Technical Service Department.

THE ROVER Co. LTD.,  
SOLIHULL,  
WARWICKSHIRE,  
ENGLAND.

Telephone :  
SHELDON 4242

Telegrams :  
Rovrepair, Solihull, England  
Telex No. : 33-156

London Service Station :

SEAGRAVE ROAD, FULHAM, LONDON, S.W.6., ENGLAND  
Telephone :  
FULham 1221

Telegrams :  
Rovrepair, Wespnone, London

## PART ONE OPERATING INSTRUCTIONS

The instruments and driving controls of your Land-Rover are situated so they can be conveniently seen and used, thus allowing maximum attention to be given to the road ahead. They are all illustrated and described on the following pages.

The paragraphs in this book are applicable to both Petrol and Diesel models unless otherwise stated in the sub-headings.

The numbers in brackets after each sub-heading refer to the illustrations on Page 4 for Petrol models and Page 5 for Diesel models.

### Points to remember, Diesel models

#### DO

- Fill the tank with *clean* fuel.
- Make sure the engine stop control is right in, run position, when starting.
- Depress the throttle pedal fully when starting.
- Use correct grade of oil for prevailing climatic conditions.
- Change C.A.V. filter element regularly; also clean sediment bowl.
- Always prime fuel system if any part of the fuel lines or filters are disconnected.
- Eliminate air from the fuel system and make sure all connections are tight.
- If the engine stops without apparent reason, make sure that fuel is reaching the distributor pump.
- Use a recommended grade of fuel, e.g. Class A, Derv, etc.
- With engine cold use heater plugs to conserve batteries; see starting procedure.

#### DON'T

- Allow fuel to get low in tank. Replenish when blue warning light flashes.
- Allow the batteries to get in a discharged condition.
- Misuse the starter switch. Wait until the engine comes to rest before each application.

Use dirty fuel. Ensure that fuel storage tanks are kept in a very clean condition and exclude dust and water.  
Attempt to start the engine unless the pump is primed with fuel.

Attempt to rectify the distributor pump. Send it to the nearest C.A.V. Agent and fit a service unit.

Allow hands and eyes to come in contact with spray from an injector nozzle, when testing.

Run engine without ensuring that the water is to the correct level in the radiator, otherwise overheating may occur with risk of nozzle sticking and other troubles.

Overtighten bolts, nuts and fuel connections.

### Ignition switch and key (7), Petrol models

Integral with the lamp switch in the centre of the instrument panel; turn the key clockwise for "on".

With the ignition "off", only the following electrical equipment can be used:—

Driving lights (head, side and tail lamps), instrument panel lights, lead lamp socket and horn.

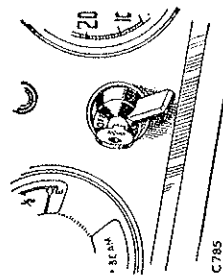

Ignition or electrical services switch and key

### Electrical services switch and key (7), early Diesel models

The key is integral with the lamp switch in the centre of the instrument panel; turn the key clockwise for "on".

Switching the key "off" will not stop the engine as does the ignition key on a petrol-engined vehicle.

The engine will run with the key "off", however it is essential to keep the key "on" when operating the vehicle, to ensure normal functioning of the electrical equipment.

Remember to switch the key "off" when the engine has been stopped.

The control marked "Engine stop" on the dash panel below the speedometer, must be pulled to stop the engine.

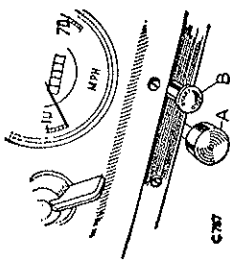

Starter switch and cold start control, Regular and Long models  
A—Starter switch  
B—Cold start control

Starter switch (24), Petrol models

'Regular' and 'Long' vehicles: on the dash panel below the instrument panel.

'Forward Control' vehicles: on the R.H. side of the instrument panel.

To operate, press and release as soon as the engine fires.

Starter and heater plug switch (25), early Diesel models

The switch, located on the dash below the instrument panel, gives a "start" position, a "heater plug" position and a combined "start" and "heater plug" position and operates as follows:—

1. When starting with a cold engine turn the key 30° anti-clockwise to the first position, current can then pass through the heater plugs causing them to glow; this raises the temperature in the combustion chamber and assists starting from cold.

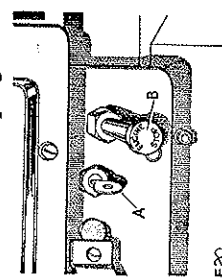

Starter and heater plug switch, early Diesel models  
A—Starter and heater switch  
B—Engine stop control

The time taken to heat the combustion chamber depends on the air and engine temperature.

For example, with a cold engine and an air temperature of 32°F, the key should be held in the first position for 10 seconds. There is a delay of 2 or 3 seconds before the warning light glows. The time required for any set of circumstances will be found with experience.

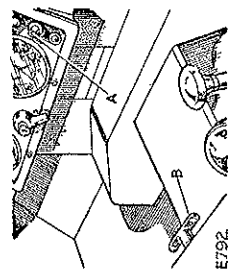

Starter switch and cold start control, Forward Control, Petrol models  
A—Starter switch  
B—Cold start control

perature in the combustion chamber and assists starting from cold.

The time taken to heat the combustion chamber depends on the air and engine temperature.

For example, with a cold engine and an air temperature of 32°F, the key should be held in the first position for 10 seconds. There is a delay of 2 or 3 seconds before the warning light glows. The time required for any set of circumstances will be found with experience.

Further movement of the key anti-clockwise to the second position will operate the starter motor and at the same time still allow current to flow to the heater plugs.

As soon as the engine is running, release the key, which will automatically return to the upright position.

2. When starting with a warm engine, turn the key clockwise—this will immediately operate the starter but does not allow any current to flow to the heater plugs.

As soon as the engine is running, release the key, which will automatically return to the upright position.

3. The starter switch key can be removed as a safety precaution.

Electrical services, starter and heater plug switch (23), late Diesel models

The switch, located on the dash below the instrument, panel gives the following positions: "Off", electrical services, heater plug, heater plug and start.

1. When starting with a cold engine, turn the key clockwise to the first position for the electrical services; continue to turn and hold key in the second position. Current can then pass through the heater plugs causing them to glow. This raises the temperature in the combustion chamber and assists starting from cold.

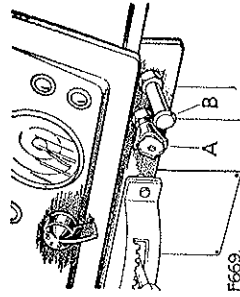

Electrical services, starter and heater plug switch, late Diesel models  
A—Switch and key  
B—Engine stop control

2. Further clockwise movement of the key operates the starter, and at the same time allows current to flow to the heater plugs. As soon as the engine fires, release the key, which will automatically return to the electrical services position.

The engine will run with the key in the "Off" position; however, it is essential to keep it in the first position to ensure normal functioning of the electrical equipment.

3. When starting with a warm engine, turn the key clockwise to the last position. Release the key as soon as the engine fires.



4. The key can be removed.

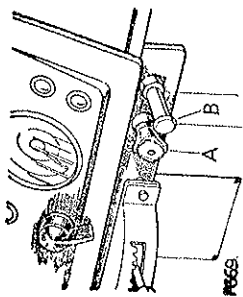

Engine stop control.  
Diesel models  
A—Starter and heater plug switch  
B—Engine stop control

#### Charging warning light (17)

The red warning light at the bottom left-hand corner of the panel appears when the dynamo fails to charge or the dynamo charging rate is low. It will glow when the ignition or electrical services key is switched on and the engine is stationary or running slowly and will go out when the engine speed rises.

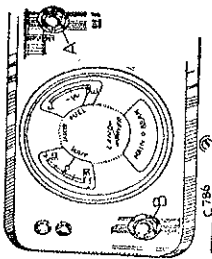

Charging and oil pressure warning lights  
A—Oil pressure warning light  
B—Charging warning light

#### Oil pressure warning light (5)

The green warning light at the top centre of the panel glows when the engine oil pressure drops below 10 to 12 lb./sq.in. (0,7 to 0,8 kg/cm<sup>2</sup>). It will light up when the engine is stationary and fade out when the engine starts and the oil pressure has built up to exceed this figure.

The light may flicker when the engine is running at idling speed, but providing it fades out immediately the engine is speeded up, the oil pressure can be considered satisfactory.

Should the warning light appear at any time when the engine is running above idling speed, stop the engine immediately and investigate the cause; usually it will be due to low oil level in the sump.

To guard against bulb failure in the oil pressure and charging warning lights, a check should be made that the bulbs glow each time the ignition is switched on.

Withdraw the instrument panel to renew bulbs.  
Replacement bulbs.

Oil and charging warning lights: Lucas No. 987 12 v., 2.2 MES.

#### Cold start control (22), Petrol models

'Regular' and 'Long' vehicles have this control, which is marked "Cold Start", mounted on the dash below the speedometer. On 'Forward Control' models it will be found on the front of the seat base, between the seats.

It is fully progressive and it is only necessary to pull it out sufficiently to start the engine.

On models with carburettor starter heater element fitted, and on 6-cylinder models, the first  $\frac{3}{8}$  in. (9,5 mm) movement gives a fast idle position without enrichment of the mixture. Further movement of the control switches on the heater element and also enriches the mixture. If the heater element is functioning an additional 3-4 amp. discharge will show on the vehicle ammeter.

The heater in operation warms the ducted air as it enters the carburettor starter body, therefore preventing an icing-up condition in that region.

The half-way position, which is indicated when a light click is felt, should be sufficient to start the engine at temperatures around freezing point.

The control should only be pulled out fully when starting at extremely low temperatures such as 0°F (-17°C) or below.

When the engine has started, the control must be returned to the normal position as soon as possible, consistent with even running and freedom from stalling.

On models with a carburettor starter heater element fitted, when returning the control to the normal position, remember that the last  $\frac{3}{8}$  in. (9,5 mm) of movement gives a fast idle position without enrichment of the mixture.

### Cold start control warning light (11), Petrol models

The appearance of the amber cold start control warning light, at the bottom right hand side of the instrument panel, will indicate that the control has been left out inadvertently and must be pushed in at once.

The cold start control warning system is not completely fool-proof and the responsibility for pushing in the cold start control rests with the driver.

Withdraw the instrument panel to renew bulb.

Replacement bulb.

Cold start control warning lamp:

Lucas No. 987, 12 v., 2.2 MES.

### Heater plug warning light (12), Diesel models

The amber warning light at the bottom right-hand corner of the panel will glow when the heater plug switch is operated; this indicates that current is being passed through the heater plugs; there is a delay of 2 or 3 seconds before it glows. If the warning light glows more brightly at any time, a short circuit in the system is indicated. No light will indicate an open circuit. This should receive attention at your nearest Rover Distributor or Dealer.

Withdraw the instrument panel to renew bulb.

Replacement bulb.

Heater plug warning light: Lucas No. 987, 12 v., 2.2 MES.

### Fuel tank level warning light (10), Diesel models

The blue warning light, fitted in the centre of dash at the right-hand side, is operated by the fuel level gauge, and lights up when the fuel level drops below 1½ gallons (7 litres), and remains "on" until the fuel supply is replenished.

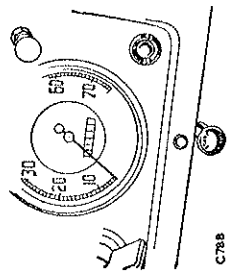

C785  
Cold start control warning light, Petrol models

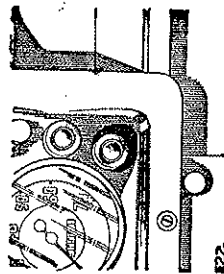

E22

Heater plug warning light, Diesel models

Intermittent flashing may occur when cornering, before the fuel level drops below 1½ gallons.

This warning light is fitted to reduce the possibility of the driver inadvertently allowing the vehicle to run out of fuel. Should the fuel supply become completely exhausted at any time, the system must be primed.

Replacement bulb.

Fuel tank warning light: Lucas No. 987, 12 v., 2.2 MES.

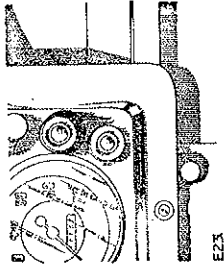

E2X

Fuel tank warning light, Diesel models

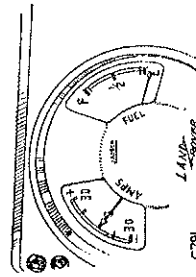

C791

Ammeter and fuel level gauge

### Ammeter (3)

The ammeter, in the multiple gauge, indicates the charging or discharging rate of the battery; usually a charge reading of three or four amperes will be shown.

When starting from cold, the charge reading will rise to a steady maximum, remain constant for a short while and then fall to a steady charge most suitable for the particular state of charge of the battery.

### Fuel level gauge (4)

The fuel level gauge, in the multiple panel, only operates with the ignition or electrical services switch "on". This gauge is not a precision instrument and cannot be used to derive fuel consumption figures.

### Main lamp switch (6)

Turn the rotary lamp switch to the required position: "OFF", to "S" for side, tail and rear number plate lamp, or "H" for headlamps, side, tail and rear number plate lamp.

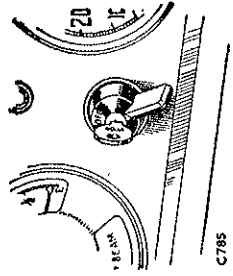

C788

Main lamp switch Petrol model illustrated

On North American vehicles, the side lamps are extinguished when the switch is moved to "H" and vice versa.

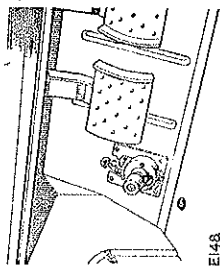

E148  
Headlamp dipper switch

#### Headlamp dipper switch (28)

When the foot-operated dipper switch, situated to the left of the clutch pedal, is used it replaces the primary filaments in both headlamps by secondary filaments directed towards the nearside of the road.

#### Headlamp warning light (18)

The small red warning light at the bottom centre of the multiple gauge glows when the primary headlamp beams are in use; its purpose is to remind the driver to switch off or dip the headlamps on entering a brightly-lit area or when approaching other traffic.

Withdraw the instrument panel to renew bulb.

Replacement bulbs.  
Headlamp warning light and instrument panel lights:  
Lucas No. 987, 12v, 2.2 M.E.S.

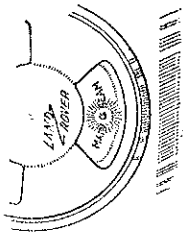

C795

Headlamp warning light

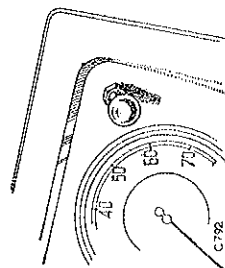

Instrument panel light switch

#### Instrument panel light switch (9)

The push-pull switch controlling the panel lights, in the top right-hand corner of the panel, is only operative with the lamp switch at "S" or "H".

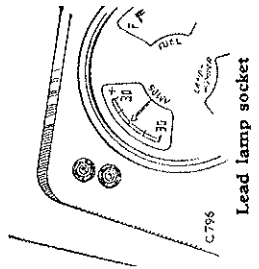

Lead lamp socket

#### Lead lamp socket (2)

In the top left-hand corner of the instrument panel are a pair of sockets which can be used either for a lead lamp or trickle battery charger; the red socket is earthed.

#### Windscreen wiper (14)

To set the wiper in operation, pull out the blade lever, turn it to clear the switch lever and turn the latter through 90°. To park the blade, reverse these operations.

To replace windscreen wiper arm and blade, slacken the fixing nut and tap sharply to release the collet which clamps the arm on to the spindle; then remove the complete assembly.

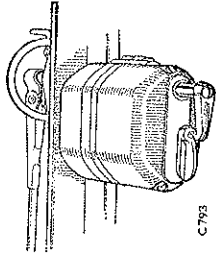

C793

Windscreen wiper

When fitting the replacement arm and blade, slacken the securing nut and push the arm boss over the end of the spindle as far as it will go. Secure by tightening the nut.

#### Headlamps

The headlamps are mounted on the radiator grille panel. To replace a bulb or sealed beam unit proceed as follows:

#### Early models

1. Slacken the clamping screw at the bottom of the headlamp rim and lift off the rim and dust-excluding rubber.
2. Press light unit against the tension of the springs on the three adjustment screws, turn it clockwise and withdraw.

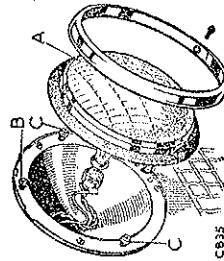

Early headlamp, replaceable bulb type illustrated

A—Light unit

B—Vertical setting screw

C—Horizontal setting screws

#### Bulb type

3. Twist the bulb adaptor in an anti-clockwise direction and pull it off the light unit.
4. The bulb can then be replaced and the unit reassembled.

#### Late models

1. L.H. lamp. Remove the two screws retaining the name plate.
2. Remove name plate and lift grille off the bottom retainers.

### Bulb type

3. L.H. and R.H. lamps. Disconnect plug at rear and release spring clip. Remove bulb holder; the bulb can then be replaced and the unit reassembled.

### Sealed beam type

4. Disconnect plug at the rear and support unit. Unscrew the three Philips recessed-head screws on grille panel, and lift out sealed beam unit.

5. Fit new sealed beam unit. Reassemble and tighten Philips recessed-head screws fully. Finally, set headlamp beam.

Model	Bulb	Sealed beam unit
R.H.D. except Sweden	Lucas 414	Lucas 54521060
R.H.D. Sweden only	Lucas 410	—
L.H.D. except Europe and France	Lucas 415	Lucas 54520481
L.H.D. France only	Lucas 411	—
L.H.D. Europe except France	Lucas 410	—
North America Dollar area	Special Sealed Beam Unit	—

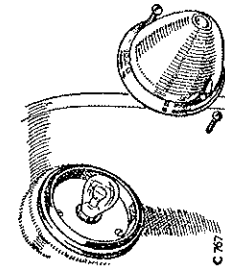

Side, tail and stop lamp bulb replacement

Remove rim retaining screws, lever the rubber bead away from the lamp and remove the rim and glass from the bottom first. Renew the bulb, move the rubber bead aside, locate the rim at the top of the lamp and press it into position; finally position the bead so that it fits snugly round the rim. Replace rim retaining screws.

Replacement bulbs.

Side lamps: Lucas No. 207, 12 v., 6 w.

Stop, tail lamps: Lucas No. 380, 12 v., 21/6 double filament

Flasher lamps: Lucas No. 382, 12 v., 21 w.

### Rear number plate illumination lamp

The rear number plate illumination lamp is mounted on the rear body.

To replace the bulb remove the securing screw and the cover; the bulb is then accessible in the lamp body.

Late models. The rear number plate illumination lamp is incorporated in the stop tail lamp.

Replacement bulb.

Rear number plate illumination lamp: Lucas No 222 12 v., 4 w.

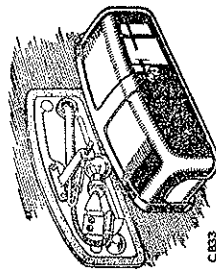

Rear number plate illumination lamp

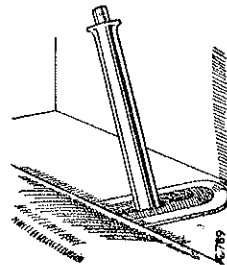

Hand brake

### Hand brake (27)

Protrudes through the front of the seat box. To release the brake, pull upwards slightly, depress the button in the top of the hand grip and push down as far as possible; to apply the brakes, pull the lever upwards.

### Gear changing. General explanation

The Land-Rover gearbox may be regarded as having 10 gear ratios, that is 8 forward speeds and 2 reverse.

For convenience in use these gears are evenly divided into two groups, termed 'Low' range and 'High' range.

'Low' range consists of four low forward gears, plus a low reverse gear.

'High' range consists of four normal gear ratios, plus a normal reverse gear.

The two ranges may be used progressively when changing up, if conditions demand.

Three gear levers are provided to control the gearbox, these being:—

1 The transfer gear lever, which is fitted with a red knob. This



control lever is used to select the high or low range of gears; it also has a neutral (mid-way) position.

The main gear lever, fitted with a black knob. This is used in the normal way, and will engage the five gears within the range selected by the transfer lever.

3. The front wheel drive control lever, fitted with a yellow knob. The use of this control is explained later.

When selecting the low range of gears with the transfer gear lever, the gearbox will automatically engage four wheel drive at the same time.

Therefore, when using the low gear range, the vehicle automatically provides maximum traction with maximum torque.

When using the high range of gears under normal conditions, the drive is to the rear wheels only.

Should the operator encounter conditions calling for four-wheel drive in the high gear range (for example, ice or mud on the road), then this may be obtained immediately, by operating the front-wheel drive control.

As an example of how the full progressive range of the gearbox may be used, consider a vehicle which is heavily laden or towing a heavy trailer, and which is required to pull away from a standing start, up a steep gradient.

With the transfer gear lever in the low range position, the vehicle will pull away in first gear, and the gear changes for the first four gears can be made in the normal way, with the main gear lever.

When road conditions are suitable for the higher gear range, they may be brought into operation without stopping the vehicle as follows:—

Depress the clutch pedal, select the high range with the transfer gear lever and move the main gear lever into the second or third gear position, depending on road conditions. Release the clutch pedal and continue to change up in the normal way.

This operation can be carried out smoothly and quickly after a little practice.

By making use of the full range of the gearbox in this manner, the clutch life will not be shortened by having to compensate for the selection of an unsuitable gear ratio.

Certain conditions concerning the use of the gearbox are now explained in detail.

### Main gear change lever (20)

The positions on the main gear change lever are marked on the lever top. It should be noted that the only reverse stop is a spring in the selector mechanism which tends to hold the lever away from the reverse selector shaft.

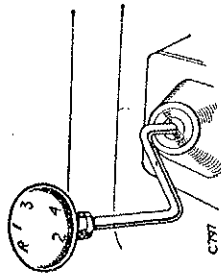

CVT  
Main gear change lever  
'Regular' and 'Long' models

Synchromesh gears are provided for changing from third to top and top to third, and in these cases single de-clutching may be used; for all other changes it is advisable to use the double de-clutch method.

### Transfer gear lever (26)

The transfer gear lever has three positions:—

1. 'High' range position, fully forward. In this position the main gear lever will select the gear ratios giving normal road speeds.
2. 'Neutral' mid-way position. Used when driving power take-off equipment.
3. 'Low' range position, fully rearwards. When in this position the low range of gears will be selected by the main gear lever.

### Transfer gear changing

Changing from 'High' to 'Low' transfer ratio should only be attempted when the vehicle is stationary. The engine may be left running, but the main gear lever must be in the neutral position. Depress the clutch pedal and pull the transfer lever right back; release the clutch. Should there be any hesitation in the gear engaging, do not force the lever. With the engine running, engage a gear with the main gear lever and let in the clutch momentarily; then return the main gear lever to neutral and try the transfer control again.

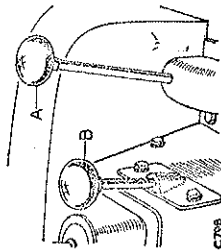

CVT  
Transfer gear change lever, and front wheel drive control  
'Regular' and 'Long' models  
A—Transfer gear change lever  
B—Front wheel drive control

## Gear change levers

The only exception to the above procedure is when the vehicle is fitted with an 'easy change' transfer gearbox. This type is fitted to 'Forward Control' models and allows the change from 'High' to 'Low' transfer, to be carried out while the vehicle is moving slowly.

Changing from 'Low' to 'High' transfer ratio may be accomplished at any time, regardless of vehicle speed. Release the accelerator pedal, depress the clutch pedal and push the transfer box lever right forward, pausing slightly in the neutral position; let in the clutch.

The important point to remember is that the vehicle must always be brought to a stand-still before changing from 'High' to 'Low' range, except on 'Forward Control' models.

### Front-wheel drive control (21)

When in 'High' transfer ratio, the vehicle may be operated in two-wheel or four-wheel drive as required; the drive to the front wheels is controlled by the gear lever with the yellow knob.

It has two positions:—

1. Disengaged. This position is fully up on 'Regular' and 'Long' models or lever to the right on 'Forward Control' models.
2. Engaged. Control pushed down on 'Regular' and 'Long' models, or to the left on 'Forward Control' models.

Front wheel drive in 'High' transfer can be engaged at any time, irrespective of road speed.

However, in order to prevent excessive tyre wear, it is strongly recommended that 30 m.p.h. (50 k.p.h.) should not be exceeded when using four-wheel drive in the high transfer, and also that a return to two-wheel drive be made as soon as road conditions permit.

In order to regain two-wheel drive, stop the vehicle, move the transfer lever to the low position then back to the high position. Front wheel drive will be automatically disengaged, and the yellow control lever will return to the disengaged position.

### General

Before moving off in the vehicle after it has been parked for some time, it is a wise precaution to check that front wheel drive is not engaged unknowingly.

The following chart showing various work conditions alongside the recommended gearbox setting will be found useful until the operator has become conversant with the gearbox.

## Gear change levers

CONTROL LEVER POSITION		Remarks	
1	Work Conditions	Normal road work	Hard pulling on road, ice or mud—land
2	Main Gear Lever	Select gear required	Select gear required
3	Transfer box lever—Red	'High' position—fully forward	'High' position—fully forward
4	Front Wheel Drive Control—Yellow	Disengaged	Engaged
5	Drive on vehicle	Driving rear wheels only through the high range of gears	Drive on four wheels, in the high range of gears
6	To obtain recommended drive setting	Check by moving transfer lever into 'Low' position—fully back, and return to the 'High' position—fully forward	Operate front wheel drive (yellow) transfer, (Red) when vehicle is in motion or stationary
7	To regain normal drive setting	—	Stop the vehicle Select 'Low' 30 m.p.h. in four wheel excessive tyre wear will take place. Return to normal drive as soon as conditions permit
8	Remarks	Carry out operations in Cot. & White engine idling, stationary, and the clutch pedal depressed	Changing to the high gear range may be accomplished with the lever forward firmly and slowly, to the High position permit

continued—

Very heavy load pulling, heavy ground descending steep gradients	Select gear required	'Low' position—Fully rearwards	Front wheel drive is automatically engaged by selection of low transfer	Drive on four wheels through the low range	Stop vehicle, depress clutch, move transfer lever to the 'Low' position—fully back	Release throttle pedal, depress clutch pedal, push transfer lever forward firmly and slowly, to the High position permit
--	----------------------	--------------------------------	---	--	--	--

Work Conditions		Vehicle on the move		Parking with heavy load on steep gradient, hand brake applied	
1	Vehicle (stationary; include hydraulic winching)	Vehicle on the move	Vehicle on steep gradient, hand brake applied	Driving rear and centre power take-off equipment	
2	Third gear selected, or position as conditions demand	Select gear required	First or reverse gear engaged		
3	Transfer box level—Red	Select 'Low' or 'High' dependent upon the R.P.M. required by the equipment in use	'Low' position—fully back		
4	Front Wheel Drive Control—Yellow	Engage if required when transfer in 'High'	Disengaged		
5	Drive condition on vehicle	Two or four wheel drive, as declared by the nature of the work	Stationary engine coupled to all wheels		
6	To obtain recommended drive setting	Engage P.T.O. selector lever and use gear-transfer control as demand	Depress clutch and select 'Low' transfer ratio; select first or reverse, stop engine and release clutch		
7	To regain normal drive setting	Select neutral P.T.O. selector lever, move main gear lever to the engaged position, and control the 'Pay-out'—'Pay-in' control lever. These remarks do not apply to the operation of the front capstan which carries its own control lever and is driven direct from the front of the engine	Depress the stationary and back to 'High' while fuel consumption		
8	Remarks	When hydraulic winching, leave the P.T.O. selector lever in the engaged position and control the 'Pay-out'—'Pay-in' control lever. These remarks do not apply to the operation of the front capstan which carries its own control lever and is driven direct from the front of the engine	Hand brake is effective on both axles in this condition		

CONTROL LEVER POSITION

Starting procedure

Starting procedure, 4-cylinder Petrol models

1. Ensure that the main gear lever is in the neutral position.
2. Start the engine as follows:—

A—Engine cold.

- (i) Pull the mixture control to the half-way out position. The control should only be pulled out fully when starting at extremely low temperatures such as 0°F (−17°C) or below.

On models with carburettor starter heater element fitted, the first  $\frac{3}{8}$  in. (9.5 mm) movement gives a fast idle position without enrichment of the mixture. Further movement of the control switches on the heater element and also enriches the mixture. If the heater element is functioning, an additional 3-4 amp. discharge will show on the vehicle ammeter.

The heater in operation warms the ducted air as it enters the starter box, therefore preventing an icing-up condition in that region.

- (ii) Keep the foot clear of the accelerator.
- (iii) Switch on the ignition, check that the green oil pressure and red charging warning lights appear.
- (iv) Press the starter button, when the engine should start after a turn or two.

Never pump the accelerator pedal when starting the engine, as the action of the carburettor accelerator pump will tend to prime the cylinders with an over-rich mixture.

B—Engine warm or hot.

- (i) Make sure the mixture control is right in.
- (ii) Depress the accelerator half-way.
- (iii) Switch on the ignition, check that the green oil pressure and red charging warning lights appear.
- (iv) Press the starter button.
- (v) Remove the foot from the accelerator as soon as the engine fires.

3. The mixture control is fully progressive and must be returned to the normal position as soon as possible, consistent with even running.

## Starting procedure

### Starting procedure, 6-cylinder Petrol models

Start the engine as follows:

1. Set the cold start control:
  - (a) Right out if the engine is cold;
  - (b) In a fast idling position if the engine is warm; the fast idle position, about  $\frac{3}{8}$  in. (10 mm) out, can be felt as the point at which the load necessary to pull out the control becomes greater. It can also be seen, if the engine is warm, as the point at which the cold start control warning light goes out when the control is pushed in.
  - (c) Right in if the engine is hot;
  - (d) With a very hot engine it may be necessary to slightly depress the accelerator pedal when starting. Remove the foot from the accelerator as soon as the engine fires.
2. Switch on the ignition, check that the green oil pressure, and red ignition warning lights appear.
3. Press the starter button, when the engine should fire after a turn or two.

If the engine makes a false start, allow the starter to come to rest before pressing the starter button again. Should the engine fail to start after two or three attempts, investigate and correct the cause before the battery is run down needlessly.

Do not race the engine; but the vehicle can be driven away at moderate speed immediately after starting.

The appearance of the AMBER WARNING LIGHT on the instrument panel will indicate that the control has been left out inadvertently and must be pushed in at once. On models with starter heater element and on 6-cylinder models, when returning the control to the normal position, the last  $\frac{3}{8}$  in. (10 mm) of movement gives a fast idle position.

### Starting procedure, Diesel models

The use of ether in capsules or in any other form must not be used to start the engine, as very high cylinder pressures are developed under these conditions, which can lead to serious and expensive mechanical failure.

The Land-Rover Diesel engine will start satisfactorily, with the proper use of the heater plugs down to temperatures of  $-20^{\circ}\text{C}$ , even with batteries only 70% charged, provided the correct grade of oil is used.

1. Ensure that the main gear lever is in the neutral position.
2. Start the engine as follows:—
  - (i) Ensure that the engine stop control is pushed right in.

## Starting procedure

- (ii) Ensure that the engine speed hand control is in the inoperative position.
  - (iii) Early models only. Switch on the electrical services key. Late models. Turn electrical services, starter and heater plug switch key clockwise to the first position.
  - (iv) Depress the accelerator fully.
  - (v) Early models. Operate the starter switch key either clockwise or anti-clockwise, depending on engine temperature. See instructions under 'Starter and heater plug switch'.
- Late models. Continue to turn the key clockwise and hold in the 'heater plug' position as required. Further clockwise movement of the key operates the starter motor. See instructions under 'Electrical services, starter and heater plug switch'.

As soon as the engine is running release the starter switch key.

Do not race the engine whilst it is still cold, for the oil has to become warm before it will lubricate the engine thoroughly.

If necessary adjust slow running with engine speed hand control to avoid stalling and maintain smooth idling speed.

Should the engine fail to start after prolonged cranking, investigate and correct the cause before the batteries are run down needlessly.

### Engine speed hand control, Diesel models

An engine speed hand control is fitted as standard equipment. It is connected to the distributor pump and limits the amount of fuel which can be injected, dependent upon the quadrant lever setting on the dash panel.

Speed control is maintained by the governor incorporated in the distributor pump.

The quadrant has a number of notches for the operating lever. The notch to the extreme right is for use when the hand speed control is not required. In order to bring the hand speed control into operation, the control lever must be moved to the left into one of the remaining notches.

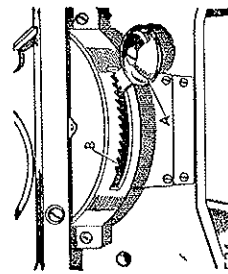

Engine hand speed control, Diesel models  
A—Quadrant lever at inoperative position  
B—Operating notches



**Running-in period**

Progressive running-in of your new vehicle is of the utmost importance and has a direct bearing on durability and smooth running throughout its life.

The running-in period is 500 miles (750 km.), during which time 35-40 m.p.h. (55-65 k.p.h.) in high transfer ratio top gear should not be exceeded. The engine must not be allowed to labour at any time and full use should be made of the indirect gears to ensure that full throttle is not used even to achieve 40 m.p.h. (65 k.p.h.). If the vehicle is used in low transfer ratio when new, 15 m.p.h. (25 k.p.h.) should not be exceeded in top gear. Corresponding maximum speeds should be used in the lower gears.

Thereafter, maximum speeds may be increased gradually, but the vehicle should not be driven at prolonged high speeds until it has done 1,000 miles (1,500 km).

Never race the engine when cold at any time during the life of the vehicle.

**Fuel consumption, 2½ litre Petrol models**

The Land-Rover has a high-powered and efficient 2½ litre engine designed for hard work under almost any conditions.

With all this power available, the vehicle is capable of sustained high speeds under normal road conditions. In common with all vehicles the petrol consumption mounts rapidly if high speeds are maintained. For example, at 50 m.p.h. (80 k.p.h.), the consumption in miles per gallon will be one and a half times as much as at 30 m.p.h. (48 k.p.h.) and at 70 m.p.h. (112 k.p.h.) the rate will be twice as much.

On 88 models there is an additional spring inserted in the accelerator linkage. This allows the accelerator to be pressed down with normal pressure for about three-quarters of its travel, thereafter higher pressure is required for the rest of the travel.

This device results in considerably improved fuel consumption, especially where the driver tends to use the full throttle opening unnecessarily.

**Free Service Inspection**

Your Rover distributor or dealer will give your Land-Rover one Free Service inspection, any oil used being charged for. This Service is provided on new Land-Rovers sold direct by the distributor or dealer to the user, on completion of the first 1,000 miles (1,500 km).

The importance of regular and systematic maintenance cannot be too highly stressed and we strongly advise the Land-Rover owner to take advantage of the free service facilities which are offered by the Rover Organisation.

In the event of an owner residing some distance from the Rover distributor or dealer from whom the vehicle was purchased, it may be more convenient for him to have the Free Service Inspection carried out elsewhere. Agreement can usually be reached with the "Vendors" of the vehicle to accept an Inter-Dealer charge at our agreed rates from another repairer for carrying out this service on their behalf, but the owner should confirm this arrangement with the "Vendors" of the vehicle beforehand.

In the case of vehicles sold in the British Isles against a Home Delivery Order (for eventual export), it becomes necessary for the owner concerned to obtain the Free Service from one of our Home distributors or dealers. The owner can obtain these facilities from any Rover distributor or dealer in the British Isles. In these circumstances the Rover Company will accept responsibility for the labour charges involved at our agreed Inter-Dealer Rates on receipt of any invoice from the distributor or dealer. The oil used will be charged to the owner.

**Bonnet**

The bonnet top panel may be secured by two lift-up spring fasteners, or by an internal spring catch at the front. Open the latter

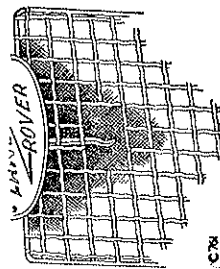

c78

Bonnet release lever, catch type

type by pressing the release lever as far to the left as possible, then raise the bonnet; and the former type by simply lifting the spring fasteners off the fixed retainers. Always secure the bonnet in the raised position by means of the support prop.

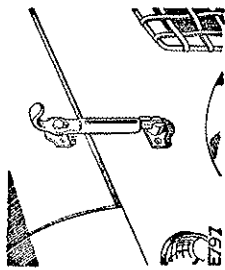

Bonnet fasteners, 'Forward Control' models illustrated

A de-luxe bonnet top panel with rounded front edge is fitted to all 'Long' models. A special version is required when the spare wheel is mounted on the bonnet of 'Regular' or 'Long' models.

### Seats

The fore-and-aft position of the driver's seat, on the 109 models, is readily adjusted by pushing to the left the lever at the left-hand side of the seat base and moving the seat into the most convenient position.

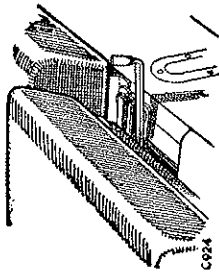

Seat adjustment—109 models

The seat cushions can be removed by lifting at the front and pulling forwards.

If the vehicle is parked during inclement weather without a covering the back rests may be folded down on to the seat cushions.

### Tool stowage

On 'Regular' and 'Long' models small tools are carried in the left-hand locker, under the seat cushion.

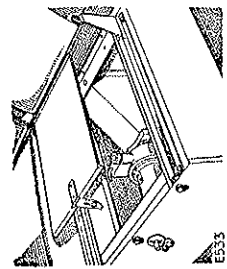

Tool stowage, 'Regular' and 'Long' models

'Forward Control' vehicles have a tool box attached to the L.H. side of the scuttle, under the bonnet. Except on some special vehicles, the starting handle and lifting jack handle extension are secured in clips on the seat backrest panel and are accessible with the seat backs lowered.

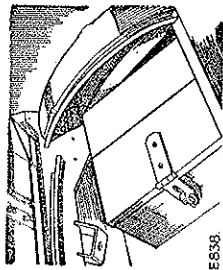

E838

Tool storage, 'Forward Control' models

### Windscreen

On canvas covered vehicles only, provision is made for folding the windscreen down on to the bonnet as follows:—

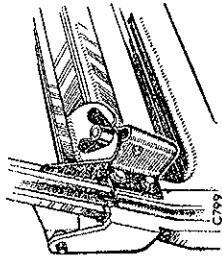

Windscreen fixing screws, early type illustrated

Remove the hood and water channels. Then disconnect the windscreen wiper lead at the plug adjacent to the wiper motor.

Early models: Slacken the wing nuts at the bottom corners of the windscreen.

Late models: Remove plastic cap and slacken nut at the bottom corners of the windscreen.

All models. Lower the windscreen to the bonnet.

### Windscreen ventilators (1)

The two ventilators in the windscreen frame may be opened independently by pushing the lever upwards until each ventilator is open to the desired position. Use of the ventilators will be found advantageous when traversing dusty roads, as they greatly reduce the amount of dust blown into the vehicle from the rear.

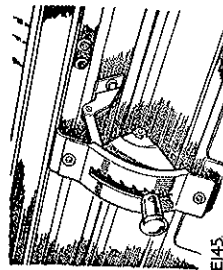

E145

Windscreen ventilators

**Spare wheel**

The spare wheel stowage position varies on different models, as follows:—

88" 'Regular'; fitted at the front of the rear body;

109" 'Long'; can be mounted in a well in front of either right or left wheelarch panel;

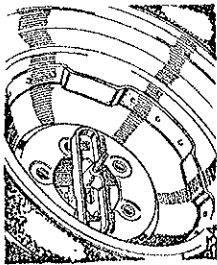

Spare wheel mounting 'Regular' and 'Long' models

'Forward Control'; carried on the chassis, at the rear of the R.H. side of cab.

It can also be fitted to the bonnet top panel on all models except 'Forward Control', as detailed in the Optional Equipment book.

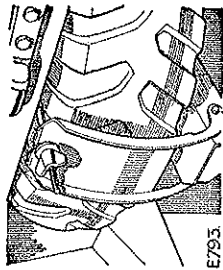

Spare wheel mounting, 'Forward Control' models

**Fuel filler**

The fuel filler cap is located at the front right-hand side of the body, with the exception of the 109 Station Wagon, which has the fuel filler cap at the rear right-hand side of the body, and Forward Control models, where it is located at the rear centre of the body.

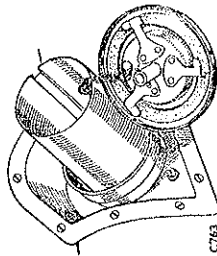

Fuel filler cap and telescopic tube

To facilitate filling when the cap is removed, a telescopic tube may be drawn out of the neck and locked by a slight anti-clockwise movement. The tank capacity is 10 Imperial gallons (45 litres), except the 109 Station Wagon and Forward Control, both of which have a standard capacity of 16 gallons (73 litres).

Petrol models. Any good brand of petrol of approximately 80 octane rating, is suitable for this vehicle. If it is desired to run the vehicle on a fuel having an octane rating of substantially less

than 80, the ignition may require slightly retarding to avoid pinking.

**Radiator filler**

Access to the radiator filler is gained by lifting the bonnet panel.

**Diesel models.** Never run the engine without water, not even for a very brief period, otherwise the injectors may be seriously damaged. This is due to the very high rate of heat transfer in the region of the injector nozzles.

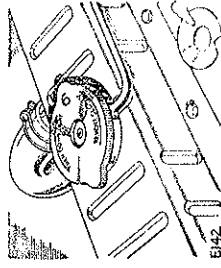

Radiator filler 'Regular' and 'Long' models

**All models**

The cooling system is pressurised and great care must be taken when removing the radiator filler cap, especially when the engine is hot, to avoid steam which may be blown out with considerable force.

When removing the filler cap, first turn it anti-clockwise to the stop and allow all pressure to escape, before pressing it down and turning further in the same direction to lift it off.

When replacing the filler cap it is important that it is tightened down fully, not just to the first stop. Failure to tighten the filler cap properly may result in the water boiling away rapidly, with possible damage to the engine through overheating.

The correct water level is approximately  $\frac{1}{4}$  to  $\frac{3}{8}$  in. (12 to 19 mm) below the bottom of the filler neck; the total capacity of the system is as follows:

Petrol models, 4-cylinder, except Forward Control, 18 pints (10,25 litres)

Forward Control, 4-cylinder, 19 pints (10,8 litres)

Forward Control, 6-cylinder, 23 pints (13,0 litres)

Diesel models, 17 $\frac{1}{2}$  pints (10,0 litres)

Use soft water wherever possible; if the local water supply is hard, rain or distilled water should be used.

**Frost precautions**

In cold weather, when the temperature may drop to or below freezing point, precautions must be taken to prevent freezing of the water in the cooling system.

As a thermostat is fitted in the system, it is possible for the radiator block to freeze in cold weather even though the engine

running temperature is quite high; for this reason, the use of an anti-freezing mixture is essential.

Only high quality inhibited glycol-base solutions should be used.

When the temperature is between 32° F and 0° F (0° C and minus 17° C) use 1 part of anti-freeze to 3 parts of water.

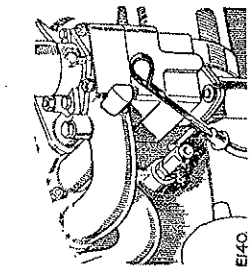

Drain tap, engine, 4-cylinder.  
Petrol models illustrated

Proceed as follows:—

1. Ensure that the cooling system is leak-proof; anti-freezing solutions are far more "searching" at joints than water.
2. Drain and flush the system.
3. Mix the solution to the required strength in a separate container and refill the system.

4. Run the engine to ensure good circulation of the mixture.

When the winter is over, as a precaution against corrosion, the anti-freezing solution should be drained off and the system flushed thoroughly again.

If the vehicle is to be stored in cold weather, unless it is kept in a well-heated garage or anti-freeze solution has been used, the cooling system must be completely drained.

During the winter months in Britain, vehicles leaving the Rover factory have the cooling system filled with 25% of anti-freeze mixture. This gives protection against frost down to 0° F (minus 17° C). Vehicles so filled can be identified by the blue label affixed to the right-hand side of the windscreen and a blue label tied to the engine.

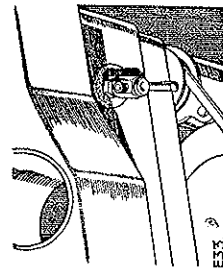

Drain tap, radiator  
Drain plug on late models

If the prevailing weather makes the use of anti-freeze mixture unnecessary when the vehicle is received, the cooling system must be drained, flushed and refilled as a precaution against corrosion. The blue labels should be removed from the windscreen and engine when this has been carried out.

## PART TWO

### ROUTINE MAINTENANCE AND ADJUSTMENTS

Lubrication and maintenance are necessary to keep your Land-Rover in good mechanical condition. All the items which require regular or occasional maintenance are shown on the following chart in terms of mileage and operation hours which would apply in a temperate climate under clean working conditions. Climatic and operating conditions affect maintenance intervals to a large extent; in many cases, therefore, the determination of such intervals must be left to the good judgment of the operator, but the recommendations will serve as a firm basis for maintenance work.

If the vehicle is used almost exclusively in low transfer ratio or for stationary work, mileage is of no use whatever in deciding maintenance intervals; lubrication attention must then be based on operation hours.

To ensure that the correct procedure is followed as each item is dealt with, it is most important that attention be transferred in turn to the appropriate page. In addition, these notes concerning more frequent attention to certain important lubrication points should be read carefully to ensure long and efficient service from the vehicle.

**Engine.** Under severe conditions of mud or dust, the first and subsequent oil changes must be more frequent, even to the extent of a daily change. Under deep wading conditions through water carrying mud and grit, a daily oil change is essential.

**Air cleaner.** When the vehicle is used for dusty road or field work, attention must be more frequent and may involve a daily oil change; under extremely bad conditions, cleaning twice daily may be called for



**Gearbox, transfer box, differentials and swivel pin housings.** It is essential to change oil much more frequently than indicated if the vehicle is operated under bad conditions, especially if deep wading is carried out.

**Propeller shafts.** Under tropical or severe conditions, particularly where sand is encountered, the sliding joints must be lubricated very frequently to prevent ingress of abrasive material.

This also applies to the fan driving shaft fitted on Forward Control models.

On late models the front propeller shaft sliding joint is sealed.

**Fuel system, Diesel models.** Absolute cleanliness is essential when dealing with the fuel system. Two filters on Home models and three on Export models are incorporated in the fuel system; they must receive regular attention to ensure efficient running and to prevent damage to the distributor pump and injectors. The quantity of fuel and general operating conditions will determine to a large extent how often the filters need attention.

#### USE ONLY

### ROVER RECOMMENDED LUBRICANTS

After exhaustive tests the recommended lubricants have been found pre-eminently suitable for Land-Rovers and should be used whenever possible. In the interests of smooth and economic running, heavier grade oil should not be used; when ordering oil, the correct grade, as well as the make, should be clearly stated.

#### Recommended lubricants

The Rover Company attaches very great importance to the nature of the lubricants used in its products and therefore maintains tests of those which it recommends.

Because of the extensive nature of these tests they cannot be carried out upon more than a strictly limited number of different makes. Consequently the Rover Company currently confines its recommendations to those set out on the next page.

Should for any reason such lubricants not be available in certain overseas territories, the Rover distributor or dealer for that territory will obtain specific guidance from the Rover Company, or owners may communicate with the Company where they so wish.

The attention of owners is drawn to the fact that the use of lubricants, other than those recommended, could in certain circumstances affect the settlement of claims put forward under the terms of the Company's guarantee.

No lubricants of other makes, grades or types are currently recommended.

Multigrade oils, produced by the makers of the lubricants listed on the next page, are also approved for the range of S.A.E. grades that they cover.

**Recommended Lubricants**

**Recommended Lubricants and Fluids**  
 These recommendations apply to temperate climates where operational temperatures may vary between approximately 10°F (-12°C) and 90°F (32°C).  
 Lubricants marked with a dagger (†) are multigrade oils suitable for all temperature ranges.  
 Information on oil recommendations for use under extreme winter or tropical conditions can be obtained from your local Rover Distributor or Dealer or The Rover Co. Ltd., Technical Service Department.

COMPONENTS	SAB	BP	CASTROL	DUCKHAM'S	ESSO	MOBIL	REGENT Texaco/ Caltex	†Shell Super Oil	RPM Delo Special 20	Rotella 20/20W	TRANSFER BOX AND GEARBOX	STEERING RELAY UNIT STEERING BOX SWIVEL PIN HOUSINGS ★DIFFERENTIALS AND GEARBOX	REAR POWER TAKE-OFF, PULLY UNIT AND CAPSTAN WINCH HYDRAULIC WINCH GEARBOX	HYDRAULIC WINCH SUPPLY TANK	LUBRICATION NIPPLES	BRAKE AND CLUTCH FLUID	ANTI-FREEZE SOLUTION															
	20W	Energol SAB 20W	†Castrol XL	†Duckham's Q20-50 Motor Oil	Esso Motor Oil 20W/30	Mobiloil Arctic	Advanced Havoline 20/20W	†Shell Super Oil	Advanced Special 20	Rotella 20/20W	ENGINE AND DIESEL MODELS AIR CLEANER	90EP	Energol SAB90EP	Castrol Hypoy	Duckham's Hypoid 90	Esso Gear Oil GP 90/140	Mobilube GX 90	Universal Thuban 90	Spirax 90 EP	Shell X-100 or Shell Tellus Oil 27	Energol HL65 20W or Castrolite	Energol L2 Engergrease	Castrolase LM	Duckham's LB10 Grease	Esso Multi- purpose Grease H	Mobilgrease MP or Special	Marlak Multi- purpose 2	Retimax A	Any good quality glycol-base solution	Shell Limited Slip Differential Oil S6721A or Mobilube 46—available in the UK market. Pure Oil TSS90, Texaco 3450 or Mobil 46—available in the North America Dollar area		
	20W	Energol D20W Diesel	Castrol CR20	NOL Diesel Engine Oil 20	Essolheat HD20	Mobiloil Arctic	RPM Delo Special 20	Rotella 20/20W			ENGINE AND DIESEL MODELS AIR CLEANER																					

On the following pages will be found full instructions on how to carry out the maintenance and adjustments required on your Land-Rover. They are detailed in the same general order as listed on the chart that follows, and as in the Maintenance Schedule Book.

The instructions are complete and any part of the vehicle not specifically mentioned does not require routine attention in this respect.

The maintenance periods in the book are given in miles and kilometres only. Refer to the chart or to the Maintenance Schedule Book for equivalent periods based on fuel consumption or hours' running time, when using the vehicle for stationary work or under arduous conditions.











## Engine oil level

Since a certain amount of oil is used up in proper operation of the engine, the oil supply must be replenished at intervals (see chart) in addition to periodic oil changes.

The oil level dipstick on the left-hand side of the engine carries three marks: Early models, H (High) L (Low) and MIN (Minimum). Late models, III, II and I MIN.

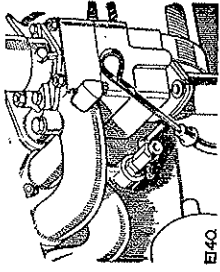

FIG 40  
Engine oil level dipstick, 4-cylinder models illustrated

When using the Land-Rover under normal circumstances the oil level should not be allowed to fall below the minimum level mark, that is the lower line on the dipstick.

However, when using the Land-Rover in circumstances which involve it being used at steep angles, the oil should not be allowed to fall below the intermediate mark, that is, the low level. This will obviate any danger of oil pump starvation when the vehicle is facing downhill at a steep angle.

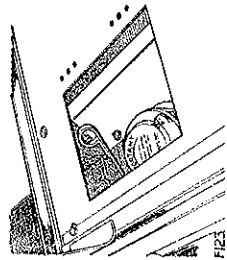

FIG 23  
Engine oil level dipstick and oil filler filter, 6 cylinder models

The oil filler is at the front of the engine.

To check the oil level proceed as follows:—

Stand the vehicle on level ground and allow a few minutes for the oil to drain back into the sump. Withdraw the dipstick upwards, wipe it clean, re-insert to its full depth and remove a second time to take the reading. Add oil as necessary; never fill above the H mark, as the engine may then require more frequent decarbonisation.

Forward Control models. Both dipstick and oil filler are accessible after removing the left-hand seat cushion and cover panels.



### Oil additives

No responsibility can be taken for damage arising from the use of any additive to the recommended lubricants.

The oils selected are complete in themselves and afford every protection. A warning is necessary against the addition of any oils or other products, as these may materially impair the character of the lubricant in use.

### Engine oil changes

When the vehicle leaves the factory, engine oil of a grade suitable for a temperate climate is in use.

The first engine oil change should be made at 1,500 miles (2,500 km); thereafter the oil must be changed every 3,000 miles (5,000 km) as follows:—

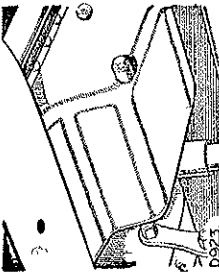

Engine sump drain plug, 4-cylinder models illustrated

Run the engine to warm up the oil, then stop. Remove the drain plug in the right-hand side of the sump. Allow the oil to drain away completely, then replace the plug.

Refill with oil of the correct grade through the filler at the front of the engine; the capacity is 11 Imperial pints (6 litres) on 4-cylinder models and 10 Imperial

pints (5,5 litres) on 6-cylinder models.

### Engine oil filter, 4-cylinder models

The oil is cleaned by means of a full-flow pressure filter mounted externally on the engine.

The element of the full-flow filter should be renewed every 6,000 miles (10,000 km). This can conveniently be done at a routine oil change.

To remove the full-flow filter element, located on the right-hand side of the engine. Place oil tray under filter. Unscrew the bolt in the bottom of the filter container and remove the container complete with the filter element. Remove and

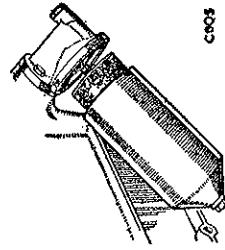

Engine oil filter, 4-cylinder models

discard the used filter element and large rubber washer. Wash the container in petrol. Place the new filter element in the container and reassemble the unit using the new large rubber washer supplied with the element. Ensure that all the sealing washers are in position and intact and that the container is correctly located in the top cover.

Refill with correct grade of engine oil and run engine for five minutes, then check for leaks. Check oil level and replenish if necessary.

### Engine oil filter, 6-cylinder models

The oil is cleaned by means of a full-flow pressure filter mounted externally on the engine

The element of the full-flow filter must be renewed every 6,000 miles (10,000 km). This should be done at a routine oil change.

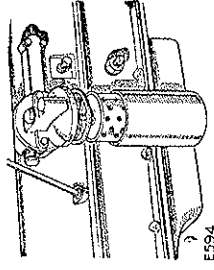

Engine oil filter, 6-cylinder models

To remove the full-flow filter element, located on the right-hand side of the engine: Place oil tray under filter.

Unscrew the bolt in the top of the filter adaptor and remove the container complete with the filter element.

Remove and discard the used filter element and large rubber washer. Wash the container in petrol. Place the new filter element in the container and reassemble the unit, using the new large rubber washer supplied with the element. Ensure that all the sealing washers are in position and intact and that the container is correctly located in the top cover.

Refill with correct grade of engine oil and run engine for five minutes, then check for leaks. Check oil level and replenish if necessary.

### Engine breather filters

The oil-wetted gauze filters fitted to the top rocker cover breather and oil filler pipe should be cleaned every 6,000 miles (10,000 km) in the following manner:

Remove the filters and wash the gauze thoroughly by swilling the units in petrol. Re-wet the gauzes by dipping in clean engine oil and shake off the surplus; replace the rocker cover filter with the slot facing forward and the oil filler filter with the slot facing the rear of the vehicle. On Forward Control 6-cylinder models the rocker cover filter is at the rear of the engine.

Under severe conditions of dust the filters must be cleaned more frequently.

### Crankcase breather filter, 6-cylinder models only

The oil-wetted gauze filter fitted to the crankcase breather on the right-hand side of the engine should be cleaned every 6,000 miles (10,000 km) in the following manner:

Remove the engine cover panel, slacken the hose clip and withdraw the filter. Wash the gauze thoroughly by swilling the unit in petrol and re-wet the gauzes by dipping in clean engine oil. Shake off the surplus and refit to breather pipe.

Under severe conditions of dust the filter must be cleaned more frequently.

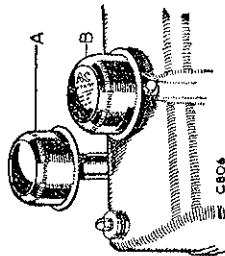

Engine breather filters, 4-cylinder models illustrated  
A—Oil filler filter  
B—Rocker cover filter

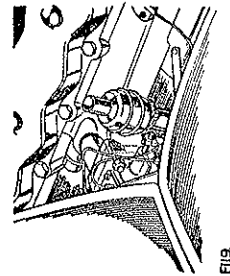

FIG. 12  
Crankcase breather filter, 6-cylinder models only

### Air cleaner

Attention to the air cleaner is extremely important, especially under dusty conditions, as engine wear generally will be seriously affected if the vehicle is run with an excessive amount of sludge in the cleaner oil bath.

Under clean road or stationary conditions, the cleaner oil bath should be cleaned and refilled

every 3,000 miles (5,000 km). In cases where the vehicle is operated under dusty road or field conditions, attention must be more frequent, even to the extent of a daily oil change; under extremely bad conditions, cleaning twice daily may be called for.

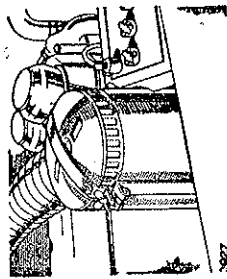

FIG. 13  
Air cleaner 'Regular' models illustrated

Proceed as follows:

1. Release the clamping strap securing the complete air cleaner.
2. Disconnect the outlet elbow from the carburettor intake pipe and remove the cleaner from the vehicle.
3. Remove the oil bowl from the bottom of the cleaner by releasing the three securing clips.
3. Clean all dirty oil and sludge from the bowl and refill with fresh engine oil to the level indicated by a ring formed in the pressing; the capacity is approximately  $1\frac{1}{2}$  Imperial pints (0,85 litre).
4. Clean the filter in the cleaner body by swilling the complete body in petrol or paraffin and shake off the surplus.
5. Replace the bowl and refit the complete unit in the vehicle

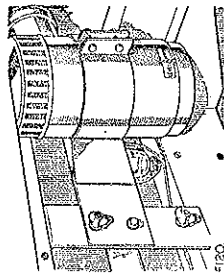
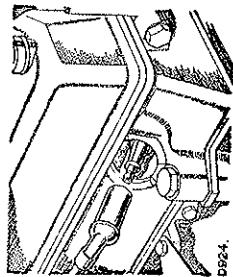

FIG. 14  
Oil bath air cleaner, Forward Control 6-cylinder models



Sparkling plug, 4-cylinder Petrol models illustrated

### Sparkling plugs, Petrol models

The sparking plugs are fitted with plastic covers. To gain access to the plugs for cleaning and gap-setting, pull up the plug covers, without detaching them from the high tension leads.

Every 6,000 miles (10,000 km) check or replace the sparking plugs; if the plugs are still in good condition clean and reset the electrode gaps to .029 to .032 in. (0.75 to 0.80 mm).

### Fuel injectors, Diesel models

Absolute cleanliness is essential when handling fuel injectors

The Pintaux injector nozzle used on the Land-Rover Diesel engine has an auxiliary spray hole to assist easy starting under cold conditions.

Nozzle holders and nozzles should not be dismantled unless proper testing and re-setting facilities are available. If a nozzle is found to be faulty, replace the complete unit.

The injectors are located in the top of the cylinder head on the right-hand side. They should be checked at every 9,000 miles (15,000 km.). Injectors may be removed for checking and adjustment as follows:—

- (a) Disconnect the spill pipe at T-piece and slacken banjo bolts at nozzles. The feed pipes must be removed from the injectors and the pump, these pipes should be free at both ends; on no account must the pipes be bent to clear the union on the injector.

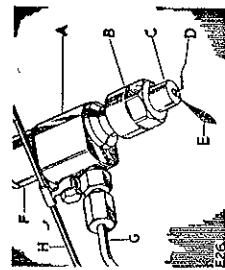

Injection nozzle, Diesel models

A—Body  
B—Nozzle retainer  
C—Nozzle  
D—Main spray  
E—Auxiliary spray  
F—Cover nut  
G—Fuel inlet  
H—Spill  
Ezc

- (b) Remove the nuts retaining the clamp bar on the top of the injector and remove the bar.

- (c) Lift out the injectors, complete with spill pipe and copper washers. Remove the steel washers from inside the injector holes.

- (d) Fit spill pipe to new injectors, ensuring that no foreign matter is present. Do not fully tighten banjo bolts at this stage. Fit assembly of injectors and spill pipe to cylinder head, taking great care not to damage nozzle and also ensure that both new copper and steel washers are fitted. The steel washer must be fitted with the 'U' of the corrugation downwards.

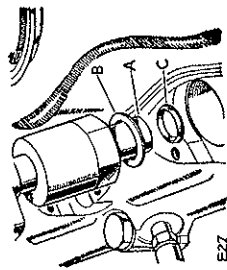

Position of injector nozzle washers, Diesel models

A—Nozzle  
B—Copper washer  
C—Steel washer

- (e) Replace the clamp bar and nuts. Tighten each nut alternately an equal amount to ensure that the injector goes into position evenly. Finally, tighten spill pipe banjo bolts.

### Checking nozzles in engine, Diesel models

The first symptoms of nozzle trouble usually come under one or more of the following headings:

- 1—Cylinder knock;
- 2—Engine overheating;
- 3—Loss of power;
- 4—Smoky exhaust (black);
- 5—Increased fuel consumption.

To check the nozzles, proceed as follows:—

- (a) With the engine running, release the fuel feed pipe union on each nozzle in turn.
- (b) If the injector being checked has been operating properly, there will be a distinct reduction in engine speed accompanied by obvious roughness, but a faulty injector will make less reduction to engine speed when its fuel pipe is loosened.

Do not assume, however, that the nozzles are the only cause of the trouble, as faulty valve timing, leaking valves, incorrect pump timing, dirty filters, etc., may all cause similar trouble.

#### Adjusting injectors, Diesel models

The use of a test pump is essential when adjusting injectors; we strongly recommend therefore, that adjustment required on injectors be carried out by your nearest Rover Distributor or Dealer or CAV Agent.

Great care should be taken to prevent the hands getting into contact with the spray, as the working pressure will cause the fuel to penetrate the skin with ease.

#### Heater plugs, Diesel models

The heater plugs do not require any maintenance. However, if at any time when the heater plug is used, the warning light glows very brightly, a short circuit in the system is indicated. No light will indicate an open circuit. This should receive attention at your nearest Rover Distributor or Dealer.

Great care must be taken not to twist the centre terminal when removing heater plug leads.

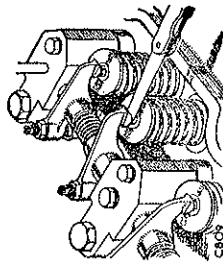

Tappet adjustment, 4-cylinder models

On 6-cylinder models the correct clearance is .006 in. (0,15 mm) for the inlet and .010 in. (0,25 mm) for the exhaust with the engine at running temperature.

Less than the correct clearance will result in a fall in power output, while greater clearance will mean noisy tappets.

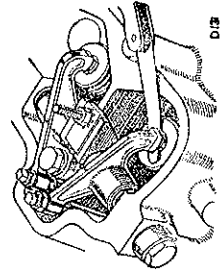

Tappet adjustment, 6-cylinder models

To carry out tappet adjustment, proceed as follows:—

1. Rotate the engine in the running direction until the valve receiving attention is fully open and then move the engine one complete turn, to bring the tappet on to the back of the cam.
2. Check the tappet clearance with a feeler gauge. If adjustment is required, slacken the locknut and rotate the tappet adjusting screw until the clearance is correct; re-tighten the locknut, taking care to ensure that this operation does not upset the clearance.
3. Repeat for the other valves in turn.

#### Flywheel markings

Ignition or injector and valve timing is based on markings on the engine flywheel which are visible, adjacent to a pointer, under the inspection cover on the right-hand side of the flywheel housing.

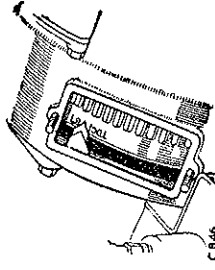

Flywheel markings

The markings and their meanings are as follows:—

1. The line against which the letters T.D.C. are stamped, when brought opposite the pointer, indicates that No. 1 (front) piston is at top dead centre, i.e., at the top of its stroke.
2. Petrol models. The line against which the figure 2°, 3° or 6° is stamped, see below, when set opposite the pointer, indicates the firing-point of No. 1 cylinder, i.e., the position at which the distributor points should be just opening, with the rotor in the firing position for No. 1 cylinder.
  - 2°—6-cylinder models when using Regular fuel
  - 3°—4-cylinder models when using Regular fuel
  - 6°—4- and 6-cylinder models when using Premium fuel

3. Diesel models. The line against which the figure 16° is stamped, when set opposite the pointer, indicates the injection-point of No. 1 cylinder, i.e., the position at which injection starts.
4. The line against which the letters E.P. are stamped, when set opposite the pointer, indicates the point at which No. 1 exhaust valve should be at the peak of its lift (fully open).

95° before T.D.C.—4-cylinder Petrol models  
 104° before T.D.C.—6-cylinder Petrol models  
 109° before T.D.C.—Diesel models

### Carburettor, Petrol models

The carburettor is adjusted on assembly and, apart from occasional cleaning of the filter, should require no further attention. The only normal adjustment provided is that to obtain smooth engine idling.

Some models have a carburettor starter heater element fitted. It is wired in conjunction with the manual and thermostatic switches operating the cold start warning light, therefore the heater element functions immediately the cold start control is pulled out beyond the fast idle position, that is, after the first  $\frac{3}{8}$  in. (10 mm) movement.

The heater in operation warms the ducted air as it enters the starter box and prevents icing up in that region.

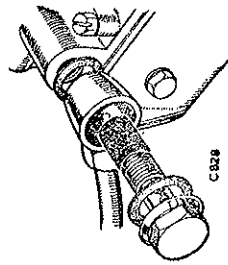

Carburettor filter, 4-cylinder Petrol models

### Cleaning carburettor filter, 4-cylinder Petrol models

Every 12,000 miles (20,000 km), disconnect the petrol pipe from the carburettor and withdraw the gauze filter from the float chamber cover. Clean the filter in petrol, using a stiff brush

### Carburettor slow-running adjustment, 4-cylinder Petrol models

Check carburettor slow running every 3,000 miles (5,000 km). To adjust the slow-running of the carburettor, proceed as follows:—

1. Run the engine until it is hot, never set the idling with a cold engine.
2. Set the slow-running screw until the idling speed is rather high
3. Slacken the volume screw until the engine begins to hunt.
4. Screw it in very gradually until the hunting just disappears.
5. If the engine speed is too high, reset the slow-running screw to slow it down to an idling speed of about 500 r.p.m.
6. This may cause a resumption of slight hunting. If so, turn the volume control screw gently in a clockwise direction until the idling is once more satisfactory.

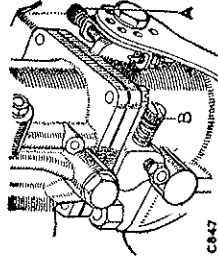

Carburettor adjustment, 4-cylinder Petrol models  
 A—Slow-running screw  
 B—Volume screw

### Cleaning carburettor jets, 4-cylinder Petrol models

It is most unlikely that trouble will be experienced with blocked jets, but the following notes will assist in location of jets which may need cleaning:—

1. Main petrol jet; the jet proper is screwed in to the inner end of the carrier, which must be removed to gain access to the jet.
2. Pilot jet has a screwdriver slot in the hexagon head.
3. Accelerator pump jet is located above the starter jet.

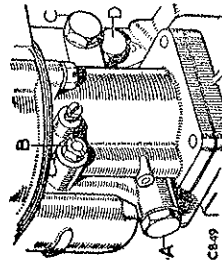

Carburettor jets, 4-cylinder Petrol models  
 A—Main jet B—Pilot jet C—Accelerator jet D—Starter jet

## Carburettor slow-running adjustment, Petrol models

4. Starter petrol jet is a plain hexagon-headed unit at the rear of the carburettor.

### Carburettor, 6-cylinder models

The horizontal dust-proof carburettor is carefully adjusted on assembly, and, apart from the few items of routine maintenance indicated below, normally requires no further attention.

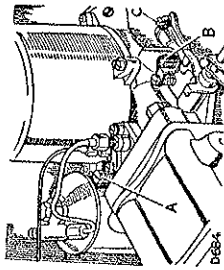

Carburettor slow-running adjustment, 6-cylinder models  
A—Slow-run valve  
B—Fast idle adjustment screw  
C—Jet adjustment screw

### Carburettor slow-running adjustment, 6-cylinder models

The only adjustments provided at the carburettor are a jet adjustment screw and a slow-run valve.

Check carburettor slow running every 3,000 miles (5,000 km).

Should the carburettor require tuning for any reason proceed as follows:

1. Run the engine until normal operating temperature is obtained. If necessary adjust slow-running valve to give the correct idling speed.

2. Lift the carburettor piston approximately  $\frac{3}{8}$  in. (1 mm) by means of the lift pin situated on the right of the carburettor body. There is approximately  $\frac{1}{8}$  in. (5 mm) free movement of the lift pin before it contacts the piston.

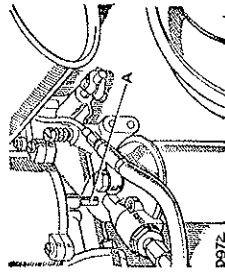

Carburettor lift-pin, 6-cylinder models  
A—Lift-pin

If the engine speeds up immediately the mixture is too rich and the jet adjustment screw must be turned anti-clockwise, thus weakening the mixture; if the engine stops immediately, the mixture is too weak and the jet adjustment screw should be turned clockwise to enrich the mixture.

If the engine just falters and continues to run unevenly the adjustment is correct.

## Distributor maintenance, Petrol models

Finally adjust the slow-run valve to get a smooth idling speed. The fast idle screw should not require adjustment.

### Carburettor maintenance, 6-cylinder models

Every 12,000 miles (20,000 km) unscrew the brass cap on top of the suction chamber, withdraw the cap and hydraulic damper, replenish the damper reservoir as necessary with SAE 20 oil and replace.

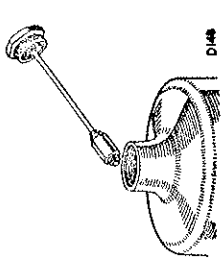

Carburettor hydraulic damper 6-cylinder models

### Distributor maintenance, Petrol models

Every 3,000 miles (5,000 km), remove the distributor cap and lubricate as follows:—

1. Lightly smear the cam with clean engine oil.
2. Lift off the rotor and add a few drops of thin machine oil to lubricate the cam bearing and distributor shaft; push the rotor on the shaft as far possible.

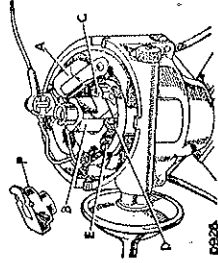

Distributor, Petrol models  
A—Condenser  
B—Cam  
C—Contact breaker pivot  
D—Contact points  
E—Screws securing movable contact  
F—Rotor arm

3. Place a drop of clean engine oil on the contact breaker lever pivot, taking care not to oil the contacts.
4. Add a few drops of thin machine oil through the hole in the contact breaker base plate, to lubricate the automatic timing control.
5. Every 3,000 miles (5,000 km) check and adjust the contact breaker clearance as follows:—

- (i) Remove the distributor cap and turn over the engine by hand until the contacts are fully open.
- (ii) The clearance should be .014 to .016 in. (0.35 to 0.40 mm).
- (iii) If necessary, slacken the two screws which secure the adjustable contact and move the plate until the clearance is correct; re-tighten the screws.
- (iv) Replace the distributor cap.



### Ignition timing, Petrol models

In addition to automatic timing advance mechanism, the distributor incorporates a hand setting control, known as the octane selector. This is a vernier adjustment attached to the distributor, fitted with a sliding portion controlled by an adjusting screw and a calibrated scale marked R (retard) and A (advance) with a number of divisions between. The standard setting for the ignition is with the long line of the scale on the sliding portion against the mark on the selector body, thus leaving one division further possible advance and four divisions retard.

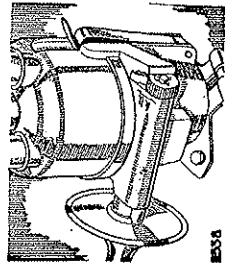

Ignition timing, 4-cylinder Petrol models illustrated

This setting is correct for 80 octane fuel and with a clean engine, but should pinking develop as a result of the need for decarbonising, the control can be retarded a little by turning the screw in a clockwise direction. Do not forget to return it to the original position after decarbonising.

In certain countries very low grade fuel is supplied, in which case it may be necessary to adjust the octane selector to avoid pinking, even with a clean engine.

Should the distributor have been disturbed, the ignition timing must be reset as follows:—

1. Set the contact breaker point gap to .014 to .016 in. (0.35 to 0.40 mm) with the points fully open.
2. Rotate the engine in the running direction until the appropriate mark, see below, on the flywheel is in line with the pointer, with both valves on No. 1 cylinder closed.
  - 2° mark—6-cylinder models when using Regular fuel
  - 3° mark—4-cylinder models when using Regular fuel
  - 6° mark—4 and 6-cylinder models when using Premium fuel

3. The distributor rotor will now correspond with No. 1 cylinder high tension lead terminal.
4. Set the octane selector so that the fourth line from the left-hand side of the calibrated slide is against the face of the distributor body casting.
5. Slacken the pinch bolt at the base of the distributor head; rotate the distributor bodily in the opposite direction to the arrow on the rotor arm until the contact breaker points are just opening with the fibre cam follower on the leading side of the cam; re-tighten the pinch bolt.

### Fan belt adjustment

Every 6,000 miles (10,000 km) the fan belt should be checked and adjusted if necessary.

As the fan belt is of the "V" type, the drive is on the sides of the belt and it is not therefore necessary to adjust it tightly and so put an excessive load on the water pump and dynamo bearings; the tension is correct when the belt can be

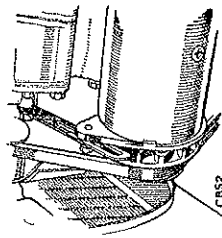

Fan belt adjustment, 'Regular' and 'Long' models

depressed  $\frac{1}{8}$  to  $\frac{1}{4}$  in. (8 to 11 mm) by thumb pressure between the fan and crankshaft pulleys. The procedure for adjustment is as follows:—

Slacken the dynamo pivot bolts and the bolt securing the dynamo to the adjusting link. Move the dynamo outwards until the tension is correct and re-tighten the bolts.

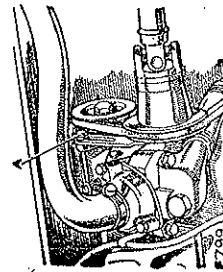

Fan belt adjustment, Forward Control models  
A—Fan belt adjuster

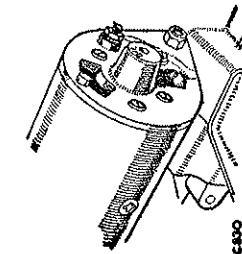

Dynamo lubrication

### Dynamo

Every 12,000 miles (20,000 km) the dynamo must be lubricated at the commutator end bearing by inserting the nozzle of a pump type oil can in the small central hole and injecting just sufficient engine oil to moisten the lubricating pad.

### Main gearbox oil level

The main gearbox and clutch withdrawal mechanism are lubricated as one unit, the oil level must be checked every 3,000 miles (5,000 km) and replenished as necessary, to the bottom of the level plug hole.

This plug is accessible from under the vehicle and can be seen from above when the rubber grommet is removed from the left-hand side of the gearbox cover.

On late models the gearbox has a combined oil level and filler plug situated on the left-hand side of the gearbox.

Engine and gearbox components on the Forward Control models, are freely accessible upon removal of the engine cover in the cab, and/or the panel in the floor of the body.

### Transfer box oil level

The transfer box and front wheel drive housing are lubricated as one unit, the oil level must be checked every 3,000 miles (5,000 km) and replenished as necessary to the bottom of the level plug hole. The

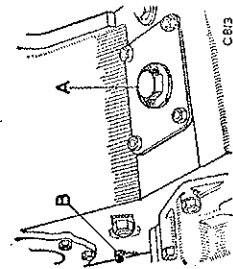
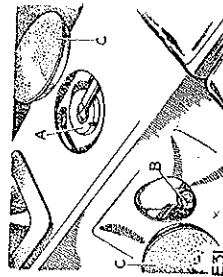
Transfer box lubrication, early type illustrated  
A—Filler cap B—Level plug

Gearbox oil filler, early type illustrated

A—Filler cap  
B—Oil level plug  
C—Rubber grommet

level plug is in the rear face of the transfer box and the filler plug on the cover plate on top of the box on the right hand side; both are accessible when the seat box centre panel is removed.

On late models the transfer box has a combined oil level and filler plug in the rear face of the transfer box casing.

### Main gearbox oil changes

The first gearbox oil change should be made at 1,500 miles (2,500 km); thereafter the oil must be changed every 9,000 miles (15,000 km) as follows:

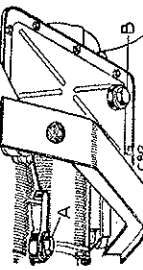

Gearbox drain plugs

A—Gearbox plug  
B—Transfer box plug

Remove the drain plug from the bottom of the main gearbox casing, immediately after a run when the oil is warm; allow the oil to drain away completely and replace the plug. Refill with oil of the correct grade; the capacity is approximately 2½ Imperial pints (1,5 litres).

### Transfer box oil changes

The first transfer box oil change should be made at 1,500 miles (2,500 km); thereafter the oil must be changed every 9,000 miles (15,000 km) as follows:

Remove the drain plug from the bottom of the transfer box immediately after a run when the oil is warm; allow the oil to drain away completely and replace the plug. Refill with oil of the correct grade; the capacity is 4½ Imperial pints (2,5 litres).

### Flywheel housing drain plug

The flywheel housing can be completely sealed to exclude mud and water under severe wading conditions, by means of a plug fitted in the bottom of the housing.

## Clutch mechanism

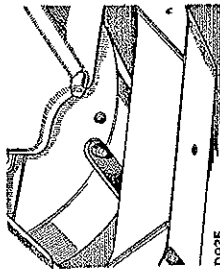

D925

Flywheel housing drain plug

The plug is screwed into a bracket adjacent to the drain hole, and should only be fitted when the vehicle is expected to do wading or very muddy work.

When the plug is in use it must be removed every 3,000 miles (5,000 km) and all oil allowed to drain off before the plug is replaced.

### Clutch fluid reservoir

The combined fluid reservoir for the brakes and clutch is mounted above the foot pedals on the engine side of the dash.

The level, which should be checked every 3,000 miles (5,000 km), is correct when the fluid is just showing in the bottom of the filter; periodically remove the filler cap and replenish as necessary, making sure that both clutch and brake reservoirs are topped up. Use Girling 'Crimson' Brake and Clutch Fluid. Specification SAE 70 R 3.

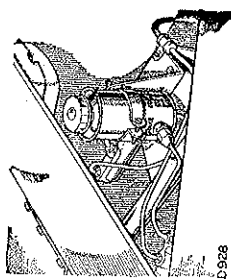

D 928

Clutch and brake fluid reservoir

### Clutch

The clutch, which is hydraulically operated, must only be used when starting the vehicle from rest or when changing gear; at all other times the foot should be kept clear of the clutch pedal to avoid unnecessary lining wear.

The hydraulic clutch system comprises a pendant foot pedal, mounted in the dash and operating a master cylinder, which in turn is connected by pipes to the slave cylinder fitted adjacent to the bell housing. The slave cylinder is connected to the clutch lever by means of an adjustable push rod.

## Clutch mechanism

### Clutch adjustment, early type only

To ensure efficient operation of the clutch unit, there must be free movement at the pedal to the extent of 1½ in. (38 mm).

This point must be checked every 3,000 miles (5,000 km). If the free movement is incorrect, adjustment must be made at the slave cylinder adjacent to the bell housing as follows:

- Slacken locknut "A".
- Adjust the push rod by means of the fixed nut "B" until the movement is correct.
- Secure with the locknut.

The adjustment at the master cylinder push rod, and the clutch foot pedal position adjustment are correctly set on initial assembly and should not be disturbed.

### Clutch mechanism, late type

Late 'Regular', 'Long' and all Forward Control models are fitted with a hydrostatic clutch, that is a clutch mechanism which is correctly set on initial assembly to give approximately ½ in. (8 mm) free movement at the pedal pad, and which

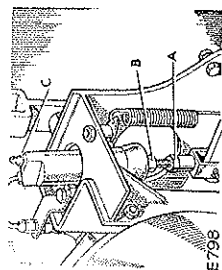

E798

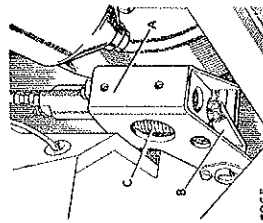
Clutch adjustment, early type  
A—Locknut B—Adjustment nut  
C—Bleed nipple

E965

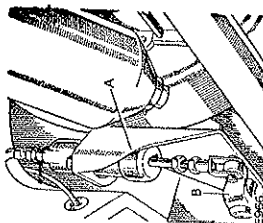
Early type clutch mechanism  
A—Enclosed slave cylinder  
B—Straight operating lever  
C—Return spring for operating lever

E966

Late type clutch mechanism  
A—Exposed slave cylinder  
B—Cranked operating rod

requires no adjustment throughout the life of the clutch plate. Models with the latest type clutch mechanism can be easily identified as follows:—

- (a) The support bracket for clutch slave cylinder on early models encloses the cylinder; on late models the cylinder is exposed.
- (b) The operating lever on early models is straight; on late models it is cranked.
- (c) The return spring is not fitted to the operating lever on late models.

All these differences are clearly shown by the illustrations on the previous page.

Do not adjust the pedal free movement on models fitted with a hydrostatic clutch.

#### Bleeding the clutch system

If the level of the fluid in the combined brake and clutch reservoir is allowed to fall too low or if the pipe has been disconnected, the clutch will not operate correctly due to air having been absorbed in the system. This air lock must be removed by bleeding the hydraulic system at the slave cylinder.

- (a) Attach a length of rubber tubing to the bleed nipple and place the lower end of the tube in a glass jar.

- (b) Slacken the nipple and pump the clutch pedal, pausing at each end of each stroke, until the fluid issuing from the tube shows no sign of air bubbles when the outlet is held below the surface of the fluid in the jar.

- (c) Hold the tube under the fluid surface and tighten the bleed screw.

- (d) Adjust pedal movement as necessary on early type only.
- (e) The fluid in the reservoir should be replenished throughout the operation to prevent another air-lock being formed. Note particularly that the fluid reservoir for the clutch is the small central tube in the combined reservoir.

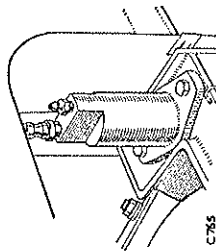

Bleed nipple for clutch slave cylinder

#### Fuel system, Petrol models

The fuel system comprises the tank, pipe lines, sediment bowl, pump, carburetter and air cleaner.

It is most important that the entire system be kept clean and free from leaks.

#### Sediment bowl, filter and fuel pump, 4-cylinder Petrol models

The mechanically operated fuel pump with hand-priming is located on the right-hand side of the engine. The sediment bowl filter is attached to it. The bowl and filter should be cleaned every 12,000 miles (20,000 km) or more frequently if an appreciable amount of foreign matter can be seen in the bowl.

To clean proceed as follows:

1. Remove the bowl by slackening the thumb screw and swinging the retainer aside.
2. Remove and clean filter gauze in petrol.
3. Ensure that the sealing washer is in good condition.
4. Replace gauze and refit bowl.
5. Prime by operating hand lever.

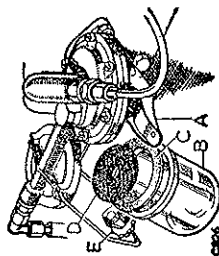

Fuel pump and sediment bowl, 4-cylinder Petrol models

A—Hand priming lever  
B—Sediment bowl  
C—Sealing washer  
D—Gauze filter  
E—Retainer

#### Fuel sediment bowl, 6-cylinder models

The sediment bowl is situated below the right-hand side member of the rear body sub-frame and attached to the air cleaner support bracket. To empty and clean sediment bowl proceed as for 4-cylinder Petrol models. The bowl is accessible either from underneath the vehicle or after removing the detachable floor panel.

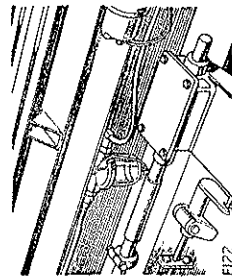

Fuel sediment bowl, 6-cylinder models

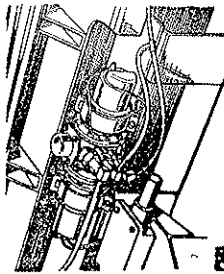

Dual fuel pump, 6-cylinder models

#### Dual fuel pump, 6-cylinder models

A dual fuel pump is fitted on the inside of the right-hand sub-frame side member.

On vehicles with one fuel tank both pumps will operate immediately the ignition is switched on, so filling the carburettor for easy starting.

With twin tank installations the pump connections are such that the primary and secondary pumps draw on the main and additional fuel tank respectively.

The secondary pump should be used once a week for a few miles' driving to ensure that it is kept in good condition.

The change-over switch is situated behind the driver's seat.

#### Fuel and injection system, Diesel models

Absolute cleanliness is essential when handling any part of the fuel injection system.

The fuel system comprises the fuel tank, pipe lines, sediment bowl filter, mechanically operated pump, paper element type filter, injectors and injection pump. It is most important that the system be kept clean and free from leaks.

#### Priming the fuel system, Diesel models

(Single or twin filter system)

A—When the filter bowl has been cleaned or the paper element changed on either or both fuel filters the system must be primed as follows:—

1. Do not attempt to start the engine hoping to draw the fuel through in this way, otherwise the full priming procedure will be necessary.

2. Slacken the bleed pipe or air vent screw as the case may be, on the top of the filter which has had the replacement element fitted.

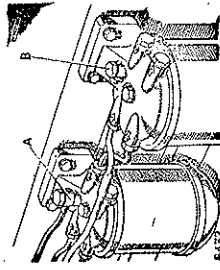

Air vent on filter, Diesel models  
Twin filter system illustrated  
A—Bleed pipe  
B—Air vent screw

3. Operate the hand priming lever on the mechanical pump, until fuel free from bubbles emerges.

4. Tighten the bleed pipe or air vent screw.

5. Operate the hand priming lever once or twice to clear the last bubbles of air into the filter bleed pipe.

6. Start engine in normal way and check for leaks.

B—When fuel system has been completely emptied proceed as follows:—

7. Carry out operations above, 1 to 5 inclusive.

8. Release air vent screw 'A' on distributor body.

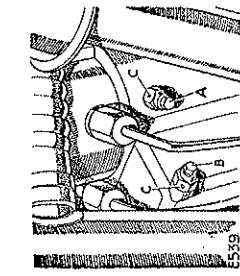

Priming the distributor pump, Diesel models  
A—Air vent screw on distributor body  
B—Air vent screw on distributor control cover  
C—Fuel on/off

9. Operate the fuel pump hand priming lever until fuel free of air emerges.

10. Retighten the air vent screw.

11. To ensure that all air is exhausted from the pump it may also be necessary to slacken air vent screw 'B' in the distributor control cover and repeat items 9 and 10.

12. Start the engine in the normal way and check for leaks.

C—When distributor pump only has been drained it is only necessary to carry out operations 8 to 12 inclusive.

Always ensure that fuel pump lever is on the bottom of the operating cam when priming the fuel system, otherwise maximum movement of the priming lever will not be obtained.

## Electrical, battery and fuse box

3. Offer the pump to the engine and engage in the splined shaft. With a small mirror, observe the setting through inspection aperture in injection pump and make any final necessary adjustment by turning the pump body to align the timing circlip as detailed above.

Hold the pump drive plate and press the skew-drive gear back against the driving side of the teeth whilst final adjustments are made and the pump secured, in order to avoid any timing errors.

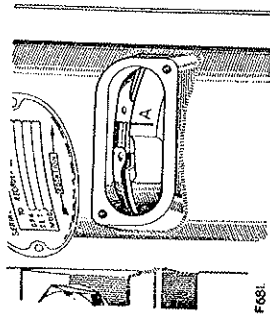

Injection pump timing marks correctly aligned—late type

4. Recheck the timing by turning the crankshaft in the direction of rotation until both valves of number one cylinder are closed and the piston is ascending the bore on the compression stroke; continue to turn the crankshaft slowly.

With a small mirror, observe that the timing mark 'A' on the pump drive plate aligns as follows:

- (a) Early models: Mark on timing circlip.

- (b) Late models: Straight edge of timing circlip.

When the above condition is obtained, the appropriate flywheel timing mark should be exactly in line with the flywheel housing pointer. In this way any slight timing error is magnified by the 2:1 ratio of the camshaft to crankshaft.

An error of a given width on the pump marking will be twelve times that width if transferred to the flywheel.

If the flywheel is inadvertently turned too far and the timing mark on the pump drive plate goes past the appropriate timing point on the circlip, the operation must be repeated.

### Battery

On Petrol models, with the exception of Forward Control models, the positive earth 12 volt battery is carried under the bonnet on the right-hand side. On Diesel models two 6 volt batteries are fitted, one under the bonnet at the

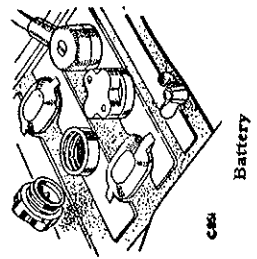

CS4

BATTERY

## Electrical, battery and fuse box

right-hand side, the other under the left-hand passenger's seat. The battery on Forward Control vehicles is carried below the body on the L.H. side of the vehicle, just to the rear of the cab.

Every 3,000 miles (5,000 km) check the battery level as follows:

1. Wipe all dirt and moisture from the battery top.

2. Remove the filler plug from each cell in turn. If necessary add sufficient distilled water to raise the level to the top of the separators. Replace the filler plug. Avoid the use of a naked light when examining the cells.

In hot climates it will be necessary to top-up the battery at more frequent intervals.

In very cold weather it is essential that the vehicle be used immediately after topping-up, to ensure that the distilled water is thoroughly mixed with the electrolyte. Neglect of this precaution may result in the distilled water freezing and causing damage to the battery.

Every 6,000 miles (10,000 km) clean, grease and tighten battery terminals.

### Fuse box

Two fuses, A2 and A4, are housed under a separate cover alongside the charging circuit control box; A4 being connected via the ignition switch, protects the windscreen wiper, fuel tank level unit, and the stop lights. Additional equipment in the form of fog lamps, interior lamps, etc., should be connected to the A2 fuse.

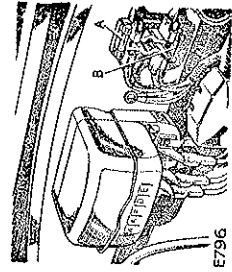

Fuse box, Petrol models, illustrated  
A—A4 fuse  
B—A2 fuse

A blown fuse is indicated by the failure of all the units protected by it and is confirmed by examination of the fuse. Before replacing a blown fuse, locate and remedy the fault in the wiring of the units which have failed. If the cause of the trouble cannot be found and a new fuse blows immediately, the vehicle should be examined at a service depot.

Two spare fuses are carried in the fuse box; only 35 amp. cartridge type fuses should be used as replacements.



## Differential lubrication

### Front and rear differential oil level

The differential oil levels must be checked every 3,000 miles (5,000 km), and replenished as necessary to the bottom of the filler plug hole. The rear axle level/filler plug is on the right-hand side of the differential casing and the front axle plug is at the front of the axle casing.

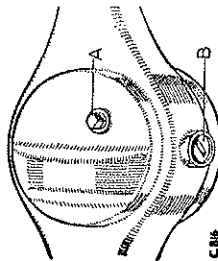

Front differential lubrication  
A—Filler/level plug  
B—Drain plug

### Driving member, front and rear axle

The oil filler plug located in the driving member is for initial filling only. During normal running the oil level is maintained from the differential and the hub requires no further attention in this respect.

If the hub is replaced or has been stripped down for any purpose, it must be filled on assembly with one-third pint of the same grade of oil as used in the differential.

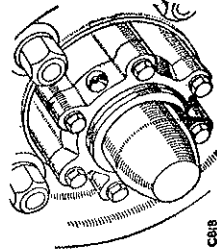

Oil filler plug, rear axle hub

### Front and rear differential oil changes

The first differential oil change should be made at 1,500 miles (2,500 km); thereafter the oil must be changed every 9,000 miles (15,000 km) as follows:

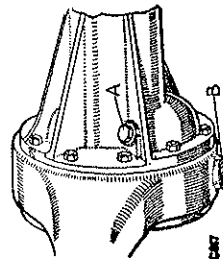

Rear differential lubrication  
A—Filler/level plug. B—Drain plug

Immediately after a run, when the oil is warm, drain off the oil by removing the drain plugs in the bottom of the axle casings.

## Steering lubrication

Replace the drain plugs and refill with oil of the correct grade; the capacity of each differential is approximately 3 Imperial pints (1,75 litres).

The drain plugs have slotted heads and can be removed with the aid of the single-ended spanner in the tool kit.

### Swivel pin housing oil level

The front wheel drive universal joints, swivel pins and front hubs receive their lubrication from the swivel pin housings; the oil levels must be checked every 3,000 miles (5,000 km) and replenished as necessary to the bottom of the filler/level plug holes at the rear of the housings.

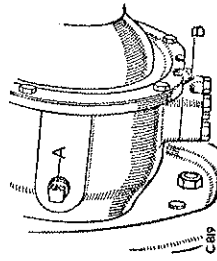

Swivel pin housing lubrication  
A—Filler/level plug B—Drain plug

### Swivel pin housing oil changes

The first oil change should be made at 1,500 miles (2,500 km); thereafter the oil must be changed every 9,000 miles (15,000 km) as follows:

Remove the drain plug from the bottom of each housing, immediately after a run when the oil is warm; allow the oil to drain away completely and replace the plugs. Refill with oil of the correct grade through the filler/level plug holes; the capacity of each housing is approximately 1 Imperial pint (0,5 litre).

### Steering box lubrication

The steering box oil level should be checked every 3,000 miles (5,000 km) and replenished as necessary to the bottom of the filler plug hole on the top of the cover plate. Access to the plug is gained by lifting the bonnet panel.

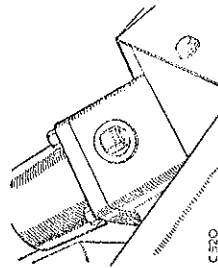

Steering box lubrication

## Steering lubrication

### Steering rod ball joints

Steering joints on the Land-Rover have been designed in such a way as to retain the initial filling of grease for the normal life of the ball joints, however this applies only if the rubber boot remains in position on the ball joint. The rubber boots should be checked every 3,000 miles (5,000 km) to ensure that they have not become dislodged, or the joint may be damaged.

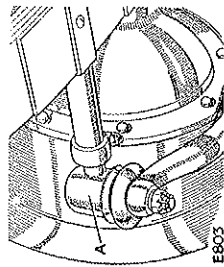

Steering rod ball joint  
A—Ball joint

To check for wear move the ball joint vigorously up and down. Should there be any appreciable free movement the complete joint must be replaced. Should any of the rubber boots be pushed out of position proceed as follows:

- (a) Remove ball end from lever;
- (b) Remove rubber boot;
- (c) Thoroughly clean all parts;
- (d) Apply one of the recommended greases round taper of ball joint and also fill the boot;
- (e) Re-assemble all parts using new rubber boots and springs as required.

### Brake system

The wheel brakes, operated by a pendant foot pedal, are of the hydraulic type, while the hand-brake operates a mechanical brake unit mounted on the output shaft from the transfer box.

When the vehicle is used in deep muddy conditions the brake drums must be periodically removed and cleaned, at the same time the brake shoes and anchor plate should be thoroughly cleaned.

When used continuously under exceptionally wet and muddy conditions this operation may be advisable once, or even twice a week, to prevent the abrasive action of packed mud rapidly wearing out brake linings and drums.

## Brake fluid level

### Servo unit, Forward Control models

Assistance to braking efficiency on Forward Control models is received, when the engine is running, from a servo unit which is coupled to the hydraulic brake system.

It will be noticed that the air intake pipe on the servo unit, has been extended by a length of plastic hose, the purpose of which is to reduce the risk of filter contamination when wading or working under adverse conditions.

The servo unit does not require any maintenance attention.

### Brake fluid reservoir

The combined fluid reservoir for the brakes and clutch is mounted above the foot pedals in front of the dash.

The level, which should be checked every 3,000 miles (5,000 km), is correct when the fluid is just showing in the bottom of the filter; periodically remove the filler cap and replenish as necessary, making sure that both clutch and brake reservoirs are topped up. Use Girling 'Crimson' Brake and Clutch Fluid. Specification SAE 70 R 3.

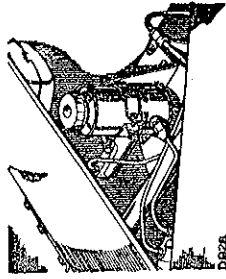

Brake and clutch fluid reservoir

### Wheel brake adjustment

When lining wear has reached the point where the pedal travel becomes excessive, it is necessary to adjust the brake shoes in closer relation to the drum. This point should be checked every 3,000 miles (5,000 km).

Proceed as follows:—

#### 88 models

Jack up each wheel in turn. On the back face of the brake anchor plate, will be found a hexagon adjustment bolt (A), which operates a snail cam bearing on the leading shoe. Only one of these is fitted to each wheel brake unit, thereby providing

## Brake adjustment

single-point adjustment. Spin the wheel and rotate the adjuster bolt until the brake shoe contacts the drum, then ease the adjuster until the wheel again rotates freely. Repeat for the other three wheels.

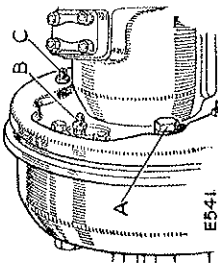

Wheel brake adjustment

A—Adjuster bolt  
B—Bleed nipple  
C—Shoe steady posts

### All 109 models

Each shoe is independently set by means of an adjuster operating through a serrated snail cam.

1. With the vehicle jacked up, ensure that the wheels rotate freely; slacken off the adjusters if necessary by turning anti-clockwise.

2. Turn the adjuster for each shoe clockwise until the shoe just brushes the brake drum, then slacken off two serrations.

### Transmission brake adjustment

Every 3,000 miles (5,000 km) check and, if necessary, adjust the transmission hand-brake unit. If adjustment is necessary proceed as follows:

Release the hand-brake. Adjustment is made by means of the adjuster wedge spindle protruding from the front of the brake backplate, accessible after removing the centre seat box panel or, in the case of Forward Control models, the floor panel in the body. Access may also be gained from beneath the vehicle. During rotation of the adjuster a click will be felt and heard at each quarter revolution. Rotate the spindle as far as possible in a clockwise direction, i.e., until the brake shoes contact the drum. Then unscrew the adjuster two clicks and give the brake a firm application to centralise the shoes; the brake drum should now be quite free to rotate. No other adjustment to the hand-brake system is necessary to compensate for lining wear.

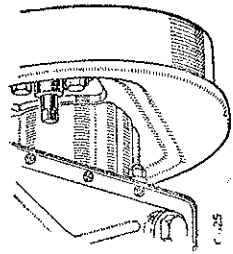

Transmission brake adjustment

## Brake adjustment

### Bleeding the brake system

If the level of fluid in the reservoir is allowed to fall too low, or if any section of the brake pipe system is disconnected, the brakes will feel "spongy", due to air having been absorbed into the system. This air lock must be removed by bleeding the hydraulic system at the wheel cylinders; bleeding must always be carried out at all wheels, irrespective of which portion of the pipe-line is affected. In addition it will be necessary to bleed the servo unit twice on Forward Control models.

The procedure at each point is exactly the same, and is as follows:—

1. Attach a length of rubber tubing to the bleed nipple being dealt with, and place the lower end of the tube in a glass jar.
2. Slacken the bleed screw and pump the brake pedal sharply two or three times and then more slowly, pausing at each end of each stroke, until the fluid issuing from the tube shows no sign of air bubbles when the outlet is held below the surface of the fluid in the jar.

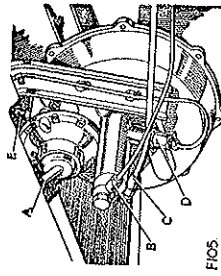

Servo unit, Forward Control models

A—Air intake pipe  
B—To wheel units  
C—To engine  
D—To master cylinder  
E—Bleed nipple

3. Hold the tube under the fluid surface and, while holding brake pedal in the depressed position, tighten the bleed screw.

The fluid in the reservoir should be replenished throughout the operation, to prevent another air-lock being formed.

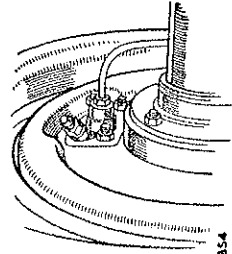

Brake bleed nipple

## Brake adjustment

**Forward Control models.** Commence by bleeding at the servo unit, situated beneath the front of the vehicle, at the R.H. side.

**All models.** Slacken the shoe adjustment cams right off.

Bleed the wheel cylinder which is farthest from the brake pedal.

Repeat for the other three wheels in turn, finishing at the one nearest the brake pedal.

**Forward Control models.** Re-bleed the servo unit.

**All models.** Re-adjust the brakes.

Note particularly that the fluid reservoir for the brake is the outer portion of the combined reservoir.

### Changing wheel positions

It is recommended that the wheels are changed round every 3,000 miles (5,000 km) to equalise tyre wear. Spare to left-hand front; left-hand front to left-hand rear; left-hand rear to right-hand front; right-hand front to right-hand rear and right-hand rear to spare.

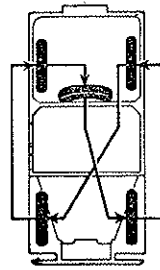

c 502

Changing wheel positions

When cross-country tyres are used the "V" tread should be directed to the front at the top.

**Warning:** Do not touch the outer ring of nuts on divided type wheels, unless the wheel is removed and the tyre fully deflated, or severe personal injury may result.

## Tyres and wheels

### Tyre pressures

Maximum tyre life and performance will only be obtained if the tyres are maintained at the correct pressures.

Regular, Long and Station Wagon	Normal				Emergency soft			
	Load under 550 lb. (250 kg)		Load over 550 lb. (250 kg)		Load under 550 lb. (250 kg)		Load over 550 lb. (250 kg)	
	Front	Rear	Front	Rear	Front	Rear	Front	Rear
88 models Avon or Dunlop 6.00 x 16.00	25 1.7	25 1.7	30 2.1	30 2.1	15 1.0	15 1.0	20 1.4	20 1.4
Avon or Dunlop 7.00 x 16.00	25 1.7	25 1.7	30 2.1	30 2.1	15 1.0	15 1.0	20 1.4	20 1.4
Avon or Dunlop 7.50 x 16.00	25 1.7	25 1.7	30 2.1	30 2.1	15 1.0	15 1.0	20 1.4	20 1.4
Michelin XY 7.50 x 16.00	15 1.0	15 1.0	22 1.5	22 1.5	10 0.7	10 0.7	16 1.1	16 1.1
109 models except Forward Control Avon or Dunlop 7.50 x 16.00	25 1.7	25 1.7	35 2.5	36 2.5	12 0.8	12 0.8	15 1.0	24 1.6
Michelin XY 7.50 x 16.00	20 1.4	20 1.4	35 2.4	35 2.4	15 1.0	15 1.0	26 1.75	26 1.75
109 Forward Control models Avon or Dunlop 9.00 x 16.00	28 2.0	18 1.3	35 2.4	30 2.1	12 0.8	12 0.8	15 1.0	15 1.0

Pressures should be checked and adjusted monthly, paying attention to the following points:—

1. Whenever possible, check with the tyres cold, as the pressure is about 2 lb. (0.1 kg.) higher at running temperature.
2. Always replace the valve caps, as they form a positive seal on the valves
3. Any unusual pressure loss (in excess of 1 to 3 lb. (0.05 to 0.20 kg.) per month) should be investigated and corrected.
4. Always check the spare wheel, so that it is ready for use at any time.
5. At the same time, remove embedded flints, etc., from the tyre treads with the aid of a penknife or similar tool. Clean off any oil or grease on the tyres, using petrol sparingly.
6. "Butyl" synthetic inner tubes are fitted and all repairs must be vulcanised.

**Body**

Every 12,000 miles (20,000 km) check tightness of body-securing bolts.

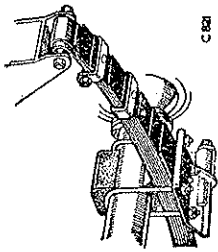

c 68

Leaf clips and U bolts

apply one of the recommended greases at the lubrication nipple on the sliding portion of the front and rear propeller shafts and fan drive shaft, (Forward Control models).

On late models the nipple on the front propeller shaft sliding joint has been replaced by a plug.

Lubricate the propeller shaft every 39,000 miles (65,000 km) as follows, using one of the recommended lubricants:

1. Disconnect one end of the propeller shaft.
2. Remove plug and fit a suitable grease nipple.
3. *Important.* Compress propeller shaft at sliding joint to avoid overfilling and apply grease.

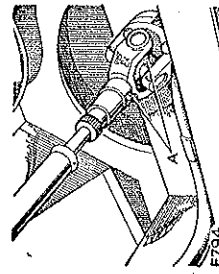

E794

Fan drive shaft, Forward Control models

A—Grease nipples

**Road springs**

Check the security of the road spring leaf clips and the nuts of the U bolts securing the axles to the springs every 12,000 miles (20,000 km); rectify as necessary.

**Propeller and fan drive shaft lubrication**

Every 3,000 miles (5,000 km)

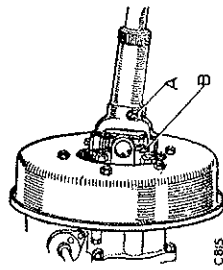

c 68

Propeller shaft lubrication

A—Sliding sleeve nipple

B—Universal joint nipple

4. Replace grease nipple with plug and reconnect propeller shaft.

At the same time, apply the correct grade of grease at the lubrication nipples fitted to the universal joints. If high pressure equipment is used, care must be taken not to damage the seals in the joints.

Late models are fitted with fully sealed universal joints which do not require any maintenance throughout their life.

**Propeller shaft bolts**

Check the securing bolts of the propeller shafts (and fan drive shaft when applicable), every 12,000 miles (20,000 km). Tighten if necessary.

**Headlamp beam setting**

Check headlamp beam setting every 6,000 miles (10,000 km).

The headlamps should be set so that the main driving beams are parallel with the road surface. If adjustment is required, proceed as follows: Early models—Remove headlamp rim as previously described. The vertical setting can then be made by turning the screw at the top of the lamp and horizontal adjustment by means of the screws at the side of the unit. Late models—Tighten the three Philips recessed-head screws fully. The setting can then be made by releasing the appropriate Philips head screw.

In order to adjust headlamps, using a beam setting board, proceed as follows:—

1. Mark on the board the dimensions shown on the illustration and position the vehicle, unladen and with correct tyre pressures, on level ground.
2. Place the board 12 ft. (365 cm) in front of the headlamps ensuring that it is at right angles to the vehicle centre line and that the centre line on the board is in the same plane as the vehicle centre line.
3. Adjust the beam by turning the adjusting screws until the area of concentrated light corresponds with the marks on the beam setting board.

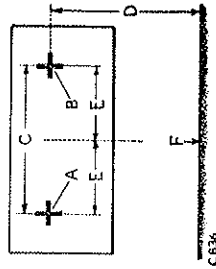

c 68

Headlamp setting board dimensions

A—Concentrated area of light—L.H. headlamp

B—Concentrated area of light—R.H. headlamp

C—20 in. (508 mm) 'Regular' and 'Long' models

42½ in. (1079 mm) 'Forward Control' models

37½ in. (945 mm) 'Long' models

35½ in. (810 mm) 'Regular' models

43½ in. (1105 mm) 'Forward Control' models

10 in. (254 mm) 'Regular' and 'Long' models

21½ in. (540 mm) 'Forward Control' models

F—Ground level

Circuit diagram, 'Regular' and 'Long', Petrol models

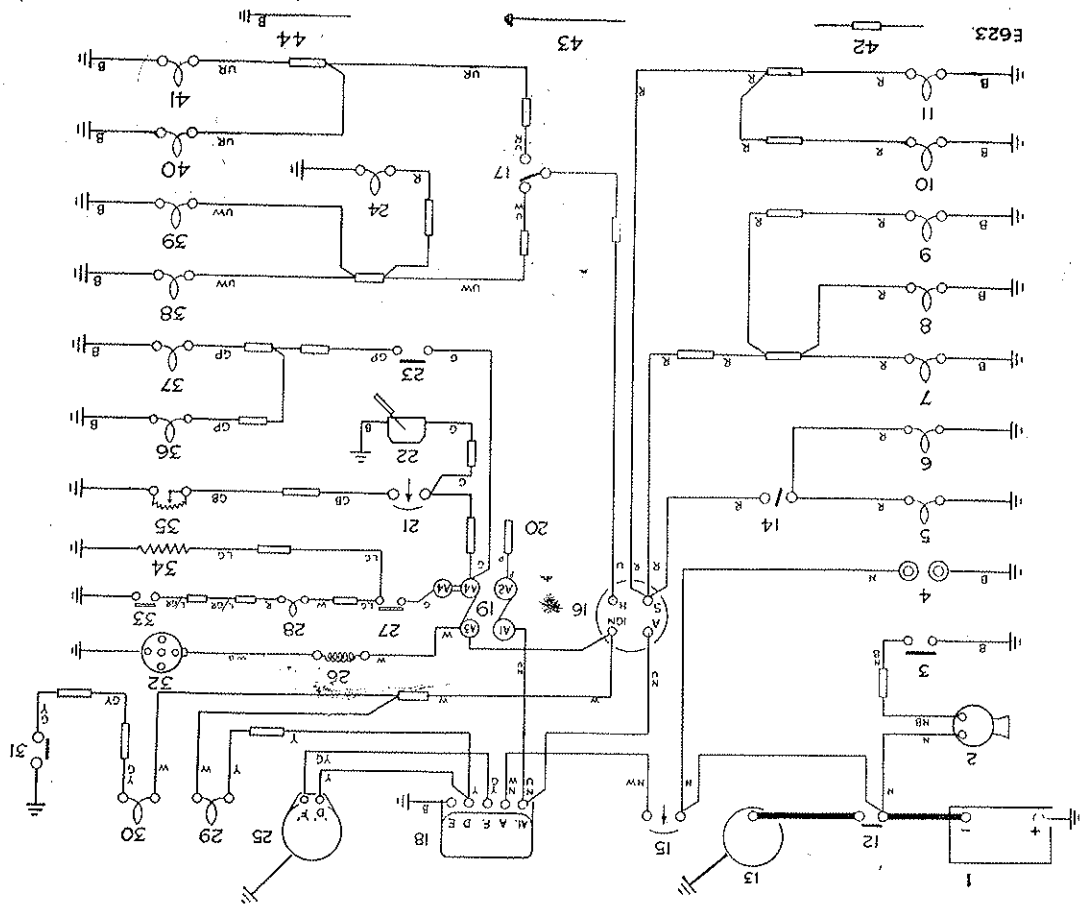

Key to circuit diagram, 'Regular' and 'Long', Petrol models

- |    |                           |    |  |
|----|---------------------------|----|--|
| 1  | Battery, 12 volt          | 16 | Ignition and lighting switch                   |
| 2  | Horn                      | 17 | Headlight dip switch                           |
| 3  | Horn push button          | 18 | Voltage control box                            |
| 4  | Inspection light sockets  | 19 | Fusebox  |
| 5  | Panel illumination        | 20 | To interior lights                             |
| 6  | Panel illumination        | 21 | Fuel gauge                                     |
| 7  | Tail light                | 22 | Screenwiper and plug and socket                |
| 8  | Number plate illumination | 23 | Stop light switch                              |
| 9  | Tail light                | 24 | Main beam warning light                        |
| 10 | Side light                | 25 | Dynamo   |
| 11 | Side light                | 26 | Ignition coil                                  |
| 12 | Starter switch            | 27 | Mixture switch                                 |
| 13 | Starter                   | 28 | Mixture warning light                          |
| 14 | Panel light switch        | 29 | Warning light, charging                        |
| 15 | Ammeter                   | 30 | Oil pressure warning light                     |
|    |                           | 31 | Oil pressure switch                            |
|    |                           | 32 | Distributor                                    |
|    |                           | 33 | Mixture thermostat switch                      |
|    |                           | 34 | Carburettor heater element, optional equipment |
|    |                           | 35 | Gauge unit, fuel tank                          |
|    |                           | 36 | Stop light                                     |
|    |                           | 37 | Stop light                                     |
|    |                           | 38 | Headlight, main                                |
|    |                           | 39 | Headlight, main                                |
|    |                           | 40 | Headlight, dip                                 |
|    |                           | 41 | Headlight, dip                                 |
|    |                           | 42 | Snap connectors                                |
|    |                           | 43 | Earth connections via fixing bolts             |
|    |                           | 44 | Earth connections via cables                   |

Key to cable colours

- |         |                   |        |          |
|---------|-------------------|--------|----------|
| B—Black | N—Brown           | R—Red  | W—White  |
| G—Green | P—Purple          | U—Blue | Y—Yellow |
| L—Light | RN—Red with Brown |        |          |

When cables have two-colour code letters the first denotes the main and the latter the tracer.



Circuit diagram, Forward Control, Petrol models

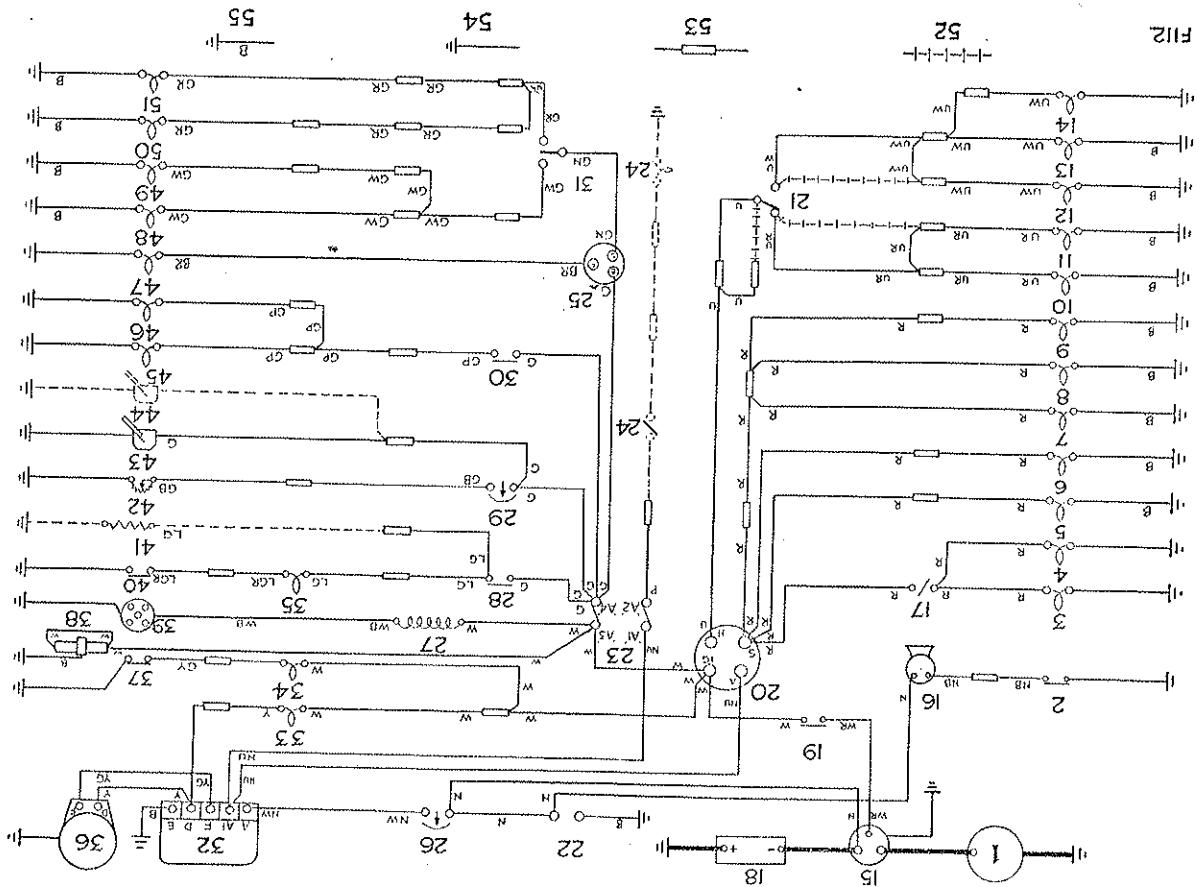

Key to circuit diagram, Forward Control Petrol models

1	Starter motor	20	Switch, lighting and ignition
2	Horn push button	21	Switch, headlamp dip
3	Panel illumination	22	Inspection socket
4	Panel illumination	23	Fuse box
5	L.H. side light	24	Interior light switch and bulb, when fitted
6	R.H. side light	25	Flasher unit
7	R.H. tail light	26	Ammeter
8	Number plate illumination	27	Ignition coil
9	L.H. tail light	28	Switch, mixture
10	R.H. head light, dip	29	Fuel gauge
11	L.H. head light, dip	30	Switch, stop light
12	L.H. head light, main beam	31	Switch, flashers
13	R.H. head light, main beam	32	Voltage control box
14	Main beam warning light	33	Warning light, charging
15	Starter solenoid	34	Warning light, oil pressure
16	Horn	35	Warning light, choke
17	Switch, panel light	36	Dynamo
18	Battery	37	Switch, oil pressure
19	Switch, starter		

38	Dual fuel pump, 6-cylinder models	W—White
39	Distributor	R—Red
40	Switch, mixture thermostat	N—Brown
41	Carburettor heater element, when fitted	G—Green
42	Gauge unit, fuel tank	P—Purple
43	Screen wiper	U—Blue
44	Second screewiper, when fitted	Y—Yellow
45	R.H. stop light	
46	L.H. stop light	
47	Warning light, flashers	
48	R.H. front flasher	
49	R.H. rear flasher	
50	L.H. rear flasher	
51	L.H. front flasher	
52	Wiring, L.H. drive models	
53	Snap connector	
54	Earth connections via fixing bolts	
55	Earth connections via cables	

When cables have two-colour code letters the first denotes the main and the latter the tracer

Key to cable colours

When cables have two-colour code letters the first denotes the main and the latter the tracer.

Key to cable colours  
 B—Black  
 N—Brown  
 R—Red  
 W—White  
 G—Green  
 P—Purple  
 U—Blue  
 Y—Yellow  
 RN—Red with Brown and so on

- |    |  |
|----|--|
| 1  | Batteries, two, 6 volt positive earth    |
| 2  | Inspection socket                        |
| 3  | Horn push button                         |
| 4  | Heater plugs                             |
| 5  | Panel illumination                       |
| 6  | Panel illumination                       |
| 7  | Tail lamp                                |
| 8  | Number plate illumination                |
| 9  | Tail lamp                                |
| 10 | Side lamp                                |
| 11 | Side lamp                                |
| 12 | Switch, starter                          |
| 13 | Horn                                     |
| 14 | Warning light, heater plug               |
| 15 | Resistor for heater plug                 |
| 16 | Starter motor                            |
| 17 | Switch, heater plug                      |
| 18 | Switch, panel light                      |
| 19 | Ammeter                                  |
| 20 | Switch, electrical services and lighting |
| 21 | Current-voltage regulator                |
| 22 | Fuse box                                 |
| 23 | To interior lights                       |
| 24 | Switch, stop light                       |
| 25 | Switch, headlamp dip                     |
| 26 | Dynamo                                   |
| 27 | Warning light, fuel level                |
| 28 | Fuel gauge                               |
| 29 | Warning light, headlamp main beam        |
| 30 | Warning light, charging                  |
| 31 | Gauge unit, fuel tank                    |
| 32 | Wiper motor                              |
| 33 | Warning light, oil pressure              |
| 34 | Switch, oil pressure warning light       |
| 35 | Stop lamp                                |
| 36 | Stop lamp                                |
| 37 | Headlamp, main beam                      |
| 38 | Headlamp, main beam                      |
| 39 | Headlamp, dip beam                       |
| 40 | Headlamp, dip beam                       |
| 41 | Snap connectors                          |
| 42 | Earth connections via fixing bolts       |
| 43 | Earth connections via cables             |

Key to circuit diagram, 'Regular' and 'Long', Diesel models with combined lighting and electrical services switch

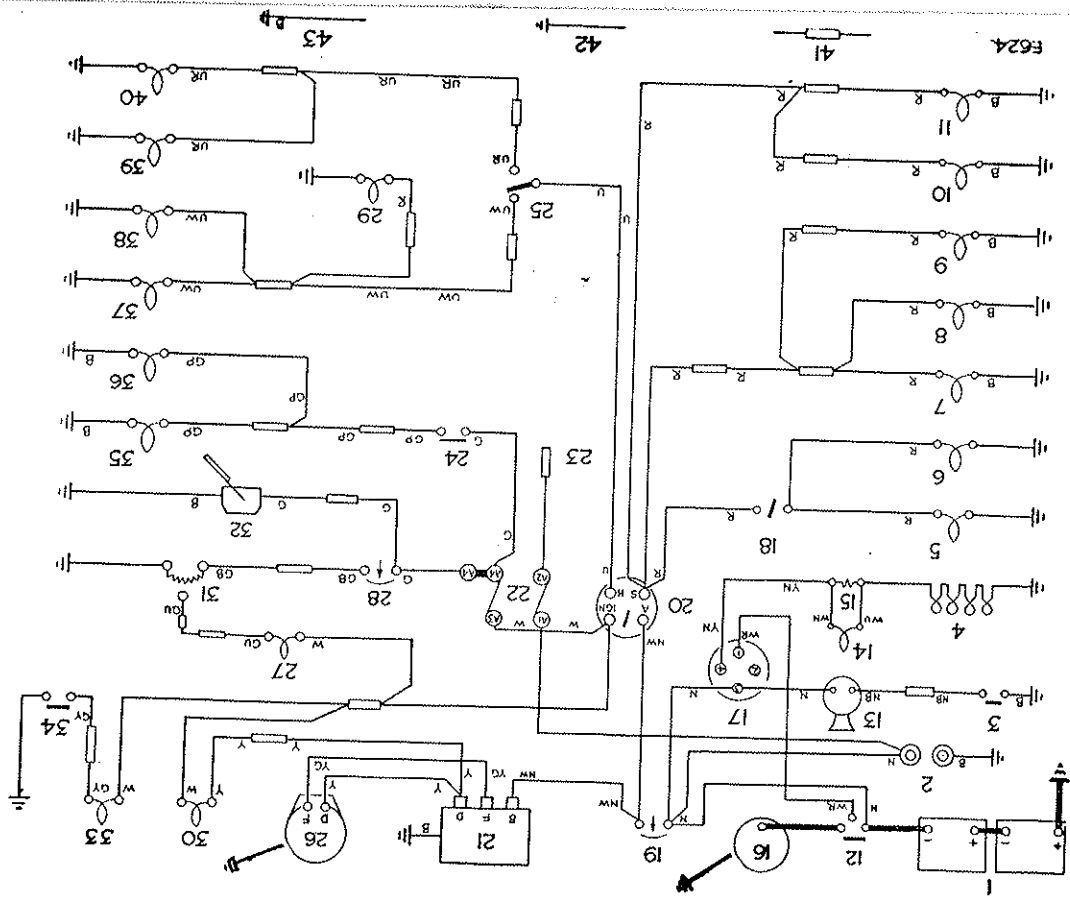

Circuit diagram, 'Regular' and 'Long', Diesel models with combined lighting and electrical services switch

When cables have two-colour code letters, the first denotes the main and the latter the tracer colour

B—Black	N—Brown	O—Orange	S—Slate
G—Green	P—Purple		
R—Red	U—Blue	L—Light	
W—White	Y—Yellow		
	RN—Red with Brown and so on		

- Key to circuit diagram, 'Regular' and 'Long', Diesel models with combined electrical services, starter and heater plug switch
- |    |   |    |   |
|----|---|----|---|
| 1  | Batteries, two, 6-volt positive earth   | 15 | Electrical services, starter and heater plug switch |
| 2  | Inspection socket                       | 16 | Switch, panel light                                 |
| 3  | Horn push-button                        | 17 | Ammeter   |
| 4  | Heater plugs                            | 18 | Lighting switch                                     |
| 5  | Panel illumination                      | 19 | Current-voltage regulator                           |
| 6  | Panel illumination                      | 20 | Fuse box  |
| 7  | Tail and number plate illumination lamp | 21 | To interior lights                                  |
| 8  | Tail and number plate illumination lamp | 22 | Switch, headlamp dip                                |
| 9  | Side lamp                               | 23 | Dynamo  |
| 10 | Side lamp                               | 24 | Warning light, fuel level                           |
| 11 | Starter motor                           | 25 | Fuel gauge  |
| 12 | Horn                                    | 26 | Switch, stop light                                  |
| 13 | Warning light, heater plug              | 27 | Warning light, headlamp main beam                   |
| 14 | Resistance for heater plug              | 28 | Warning light, charging                             |
|    |   | 29 | Gauge unit, fuel tank                               |
|    |   | 30 | Windscreen wiper motor                              |
|    |   | 31 | Warning light, oil pressure                         |
|    |   | 32 | Switch, oil pressure warning light                  |
|    |   | 33 | Stop lamp   |
|    |   | 34 | Stop lamp   |
|    |   | 35 | Headlamp, main beam                                 |
|    |   | 36 | Headlamp, main beam                                 |
|    |   | 37 | Headlamp, dip beam                                  |
|    |   | 38 | Headlamp, dip beam                                  |
|    |   | 39 | Snap connectors                                     |
|    |   | 40 | Earth connections via terminals or fixing bolts     |
|    |   | 41 | Earth connections via cables                        |

Circuit diagrams

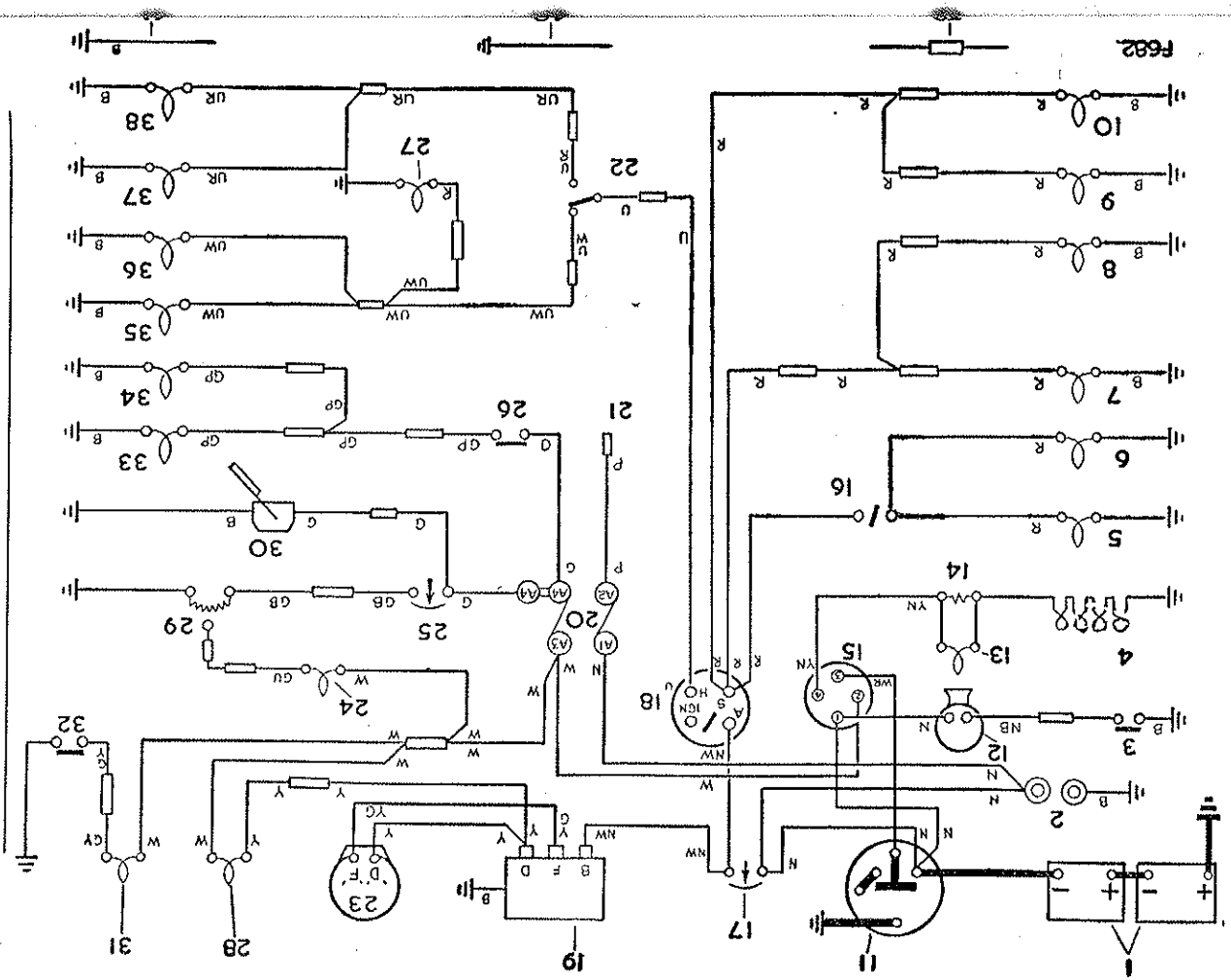

Circuit diagram, 'Regular' and 'Long', Diesel models with combined electrical services, starter and heater plug switch

Circuit diagrams

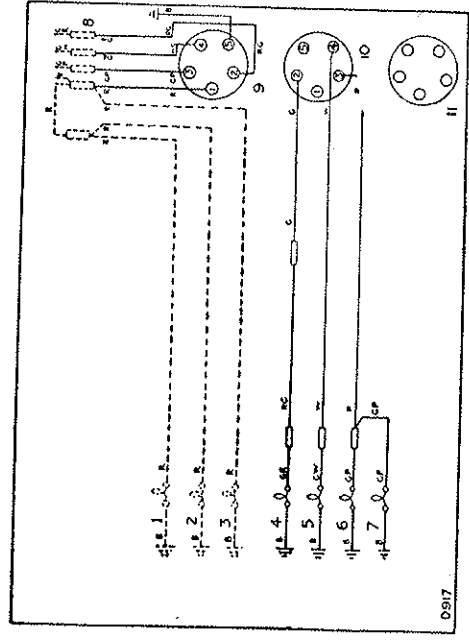

Flasher plug on vehicle

D917

Key to flasher plug on vehicle

- 1 Existing L.H. tail lamp
- 2 Existing number plate lamp
- 3 Existing R.H. tail lamp
- 4 Flasher L.H.
- 5 Flasher R.H.
- 6 Stop lamp L.H.
- 7 Stop lamp R.H.
- 8 Existing snap connectors
- 9 Socket on vehicle
- 10 Flasher plug
- 11 Dummy socket

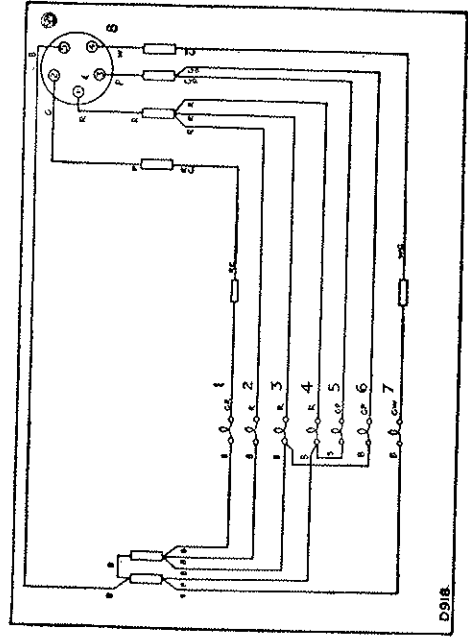

Flasher plug on trailer

D918

Key to flasher plug on trailer

- 1 Flasher lamp L.H.
- 2 Number plate lamp
- 3 Tail lamp L.H.
- 4 Tail lamp R.H.
- 5 Stop lamp R.H.
- 6 Stop lamp L.H.
- 7 Flasher lamp R.H.
- 8 Plug on trailer

- 21 Snap connectors
- 22 Earth connections via terminals and fixing bolts
- 23 Junction box terminals
- 24 circuits shown dotted are existing on vehicle

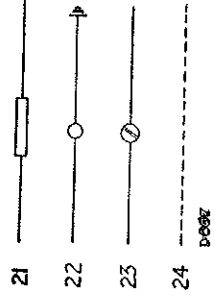

D918

### Optional equipment

Some of the optional equipment which may be fitted to the Land-Rover requires maintenance attention at regular intervals, or may need some explanation concerning its use.

These details are not included in the Maintenance Chart, but are given on the pages which follow, under the appropriate heading.

Full details of all the optional equipment available for the Land-Rover are contained in a separate book, from which the following is an extract, and is obtainable free of charge from The Rover Co. Ltd., Technical Service Department, Solihull, Warwickshire, England.

### Dust-proofed engine breather, Petrol models

Suitable for 2½ litre petrol engines only. This breather replaces the normal oil filler cap. It must not be fitted to vehicles operating under cold and misty conditions.

The oil in the engine breather must be renewed weekly. If, however, the vehicle is operating under extremely dusty conditions, this change of oil should be carried out daily.

When removing the oil bath breather on the oil filler, care must be taken to hold it upright to avoid spilling the oil.

On vehicles fitted with a raised air intake and a dust proofed engine breather, the normal air cleaner should be cleaned more frequently.

### Raised air intake, Petrol models only

Suitable for 2½ litre petrol models only, it comprises an air intake for the air cleaner attached to the front R.H. side of the windscreen, or the rear L.H. side of the cab on Forward Control

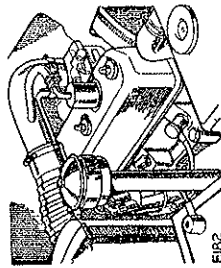

582.  
Dust-proofed engine breather  
'Regular' and 'Long' models  
illustrated

models. The engine breather on the top rocker cover is connected to an elbow between carburetter and air cleaner.

This optional equipment must only be used in conjunction with the dust-proofed engine breather described previously.

It must receive occasional attention by removing the centrifugal air intake and blowing out any foreign matter which may be adhering to it.

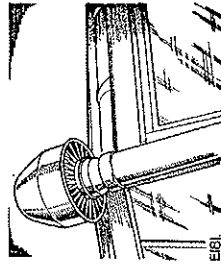

581.  
Raised air intake  
'Regular' and 'Long' models  
illustrated

### Power take-off units

Operating instructions for the power take-off units together with pulley, engine and road speeds are contained in a separate book, Part No. 4643; copies obtainable on request to:

The Rover Company Ltd.,  
Technical Service Dept.,  
Solihull, Warwickshire,  
ENGLAND.

### Centre power take-off

The driving pulley, usually of the multi-belt pattern, bolts directly on to the flanged output shaft. Operation and maintenance instructions for the driven equipment will be provided with the equipment and is available from the manufacturer. When the drive is by vee belt, not more than 20-25 B.H.P. can be transmitted through the centre power take-off, or damage to the rear engine mountings will result.

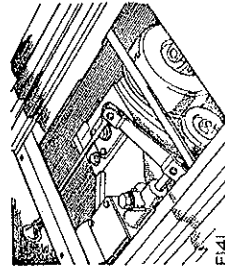

E41.  
Centre power take-off  
'Regular' and 'Long' model  
illustrated

### Optional equipment

#### Centre power take-off maintenance

The belt drive to the driven equipment must be adjusted periodically, to ensure that the tension is correct. It should be possible to depress the belts by thumb pressure  $\frac{1}{2}$  to 1 in. (12 to 25 mm.) at a point midway between the pulleys.

In the case of multi-belt drives, all must be renewed if one belt breaks or is damaged. Whenever the belts are removed they should be marked to ensure replacement in the original grooves.

#### Rear power take-off, 'Regular' and 'Long' models

The rear power take-off unit, mounted on the rear chassis cross-member, is driven by a propeller shaft from the flanged output shaft at the rear of the gearbox; the standard S.A.E. six-splined output shaft is on the centre-line of the vehicle and provides power for towed equipment.

#### Rear power take-off maintenance

1. Oil level. The oil level must be checked at every 40 operation hours and replenished as necessary to the bottom of the filler/level plug hole on the side of the casing.
2. Oil changes. The oil should be completely drained from the unit after the first 30 hours and thereafter at intervals of six months by removing the drain plug from the bottom of the casing; refill to the bottom of the level plug hole with oil of the recommended grade. The oil capacity is approximately 1 Imperial pint (0,5 litre).

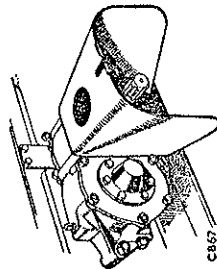

Rear power take-off 'Regular' and 'Long' models

the unit after the first 30 hours and thereafter at intervals of six months by removing the drain plug from the bottom of the casing; refill to the bottom of the level plug hole with oil of the recommended grade. The oil capacity is approximately 1 Imperial pint (0,5 litre).

3. Propeller shaft. Lubricate the propeller shaft as applicable with grease of the correct grade at intervals of six month

### Optional equipment

#### Rear drive pulley, 'Regular' and 'Long' models

The 8 in. (200 mm.) rear drive pulley unit may be attached to the rear power take-off unit in place of the guard by means of four spring washers and nuts. Difficulty would be experienced in holding the vehicle steady if more than 20 B.H.P. is transmitted through the pulley.

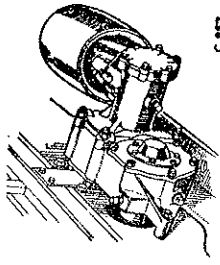

Rear drive pulley 'Regular' and 'Long' models

#### Rear drive pulley maintenance

1. Oil level. The oil level must be checked at every 40 operation hours and replenished as necessary to the bottom of the filler/level plug hole in the side of the casing.
2. Oil changes. The oil should be completely drained from the unit after the first 30 hours and thereafter at intervals of six months by removing the unit from the vehicle and pouring out the oil through the filler/level plug hole. Refill to the bottom of the filler/level plug hole with oil of the recommended grade; the capacity is approximately  $\frac{3}{4}$  Imperial pint (0,5 litre).

#### Oil cooler

An engine oil cooler must be fitted when the vehicle is used to drive stationary equipment under conditions in excess of:—

Power required: 24 B.H.P. at 2,000 R.P.M. —Petrol models	} Diesel models
20 B.H.P. at 1,500 R.P.M.	
24 B.H.P. at 2,000 R.P.M.	
20 B.H.P. at 2,500 R.P.M.	
10 B.H.P. at 3,000 R.P.M.	

Ambient air temperatures: 20°C. (68°F).

Running time: 30 minutes.

## Optional equipment

It incorporates a cooling radiator inserted in the engine oil system and mounted just in front of the radiator; a gauge on the dash panel gives continuous indication of the oil temperature.

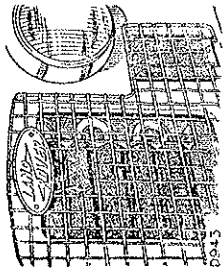

Oil cooler  
'Regular' and 'Long' models  
illustrated

The oil temperature should never exceed 90°C. and the engine must be switched off and the oil allowed to cool down if this temperature is reached under working conditions.

### Engine governor, Petrol models only

An engine governor may be fitted when a centre power take-off or rear drive pulley is used; it would also simplify many jobs necessitating use of the rear splined output shaft.

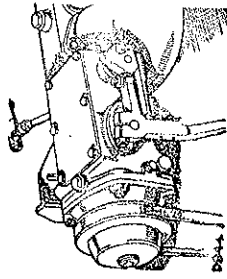

Engine governor, Petrol models

### Engine governor maintenance

Every 40 operation hours, check the oil level in the governor body by removing the filler plug at the top front and the level plug at the left-hand side; replenish as necessary with engine oil through the filler hole, until the level is to the bottom of the level plug hole. Replace both plugs.

## Optional equipment

### Hydraulic winch

This comprises a hydraulic drum winch, with cable, which is mounted at the front of the vehicle on 'Regular' and 'Long' models, or in a central chassis position, beneath the body, on Forward Control models.

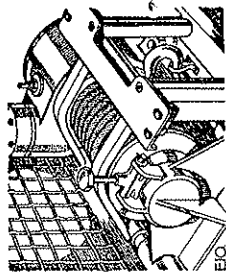

It is driven by a hydraulic pump fitted to the rear of the transfer box. Operating controls are fitted to the heel board, inside the cab, and a hydraulic oil supply tank is fitted in the rear L.H. side wheelarch on 'Regular' and 'Long' models, or at the rear R.H. side of the vehicle on Forward Control models.

Hydraulic winch  
'Regular' and 'Long' installations

The following details are applicable to the Forward Control installation only.

A spring-loaded roller is fitted to the drum; this retains the rope if the pull falls off.

A guide ensures even rope lay on the drum when the pull is in the region of 400 lbs. (182 kg).

The rope hook is removable in order that the rope may be threaded to the front or rear of the vehicle.

When winching from the rear the rope is fed from the drum, through the guide bracket, between two of the guide wheels and through the rear rollers.

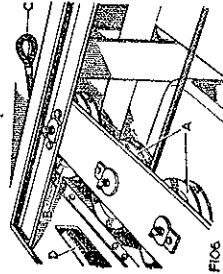

Cable guide wheels, Forward Control models  
A—Guide wheels, rope to rear  
B—Guide wheel, rope to front  
C—Cable end  
D—Rear rollers

To winch from the front of the vehicle; remove the hook, pass the rope back through the rear rollers and around the third guide wheel, through the pigtail guide brackets on the L.H. side chassis member, to the front roller box on front bumper bar. Remove one of the retaining bolts and a roller, and slacken the nut on the other retaining bolt.



## Optional equipment

Pass the rope through the box, then replace the roller, bolt, spring washer and nut. Retighten both nuts and refit the rope hook.

Instructions for using hydraulic winch, all models.

1. Vehicle should be positioned in line with the object to be recovered, or in the case of self-recovery the end of the cable should be anchored in line with the vehicle.
2. The transfer box lever should be placed in the neutral position.
3. Engage 3rd gear in the main gearbox and pull out the power take-off lever protruding through the heel board. The hydraulic pump will then be driving when the clutch is released.

The engine should be run at approximately 2,000 r.p.m., which will result in the pump being driven around 1,500 r.p.m. In practice the engine can be controlled during self-recovery by the accelerator pedal, but for some applications the hand throttle can be used.

4. The hydraulic control lever protruding from the heel board, can now be moved to the desired "Pay-out" or "Pay-in" position. Upon releasing this control it will automatically return to the central (neutral) position.

To "Pay-out" the cable, push the control lever downwards, or on the Forward Control installation push the control inwards. Reverse the movement to "Pay-in" the cable.

The following points should be noted:

1. The control for the engagement of the cable drum to the driving shaft, on the front installation is on the R.H. side of the winch unit, and on Forward Control models is midway down the L.H. side chassis member. Pull this control outwards to engage.

## Optional equipment

When disengaged for a rapid run-out of the cable, two inbuilt brake pads prevent over-run of the drum, which would otherwise cause the cable to spring into loose coils.

2. When rewinding the slack cable after a winching operation, it is necessary to apply some resistance to the cable to obtain a neat and even lay on the drum.

With the front-mounted installation, an assistant holding the end of the cable against the pull of the drum will be found sufficient.

The Forward Control installation will require resistance in the region of 400 lbs. (182 kg).

This may be obtained by such means as winching in another vehicle on which the brakes are lightly applied, or alternatively by anchoring the cable to a tree or ground anchor and allowing the winch to pull the vehicle along, while the brakes are held lightly applied.

3. If the overload safety valve operates during a winching operation (indicating that the maximum pull has been exceeded) the control valve can be moved to the "Pay-out" position and then re-engaged to "Pay-in" position.
4. When recovery or self-recovery operations take place on a very steep slope, the maximum pull sometimes is exceeded due to the angle of the cable when the vehicle has reached the apex of the hill. If the safety valve operates it will sometimes be found that a restart is not possible. In these circumstances the vehicle should be lowered a certain amount in the "Pay-out" position, and a further attempt made after the tension in the cable has been reduced.
5. Ground anchors, sprags under the wheels, other vehicles, trees, etc., can be used for securing the vehicle when it is used for general winching or for securing the end of the cable when

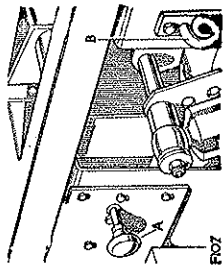

Engagement control, drum to shaft, Forward Control models  
A—Control knob  
B—Cable guide bracket

## Optional equipment

self-recovery is necessary. The safety valve in the pressure line of the hydraulic system will prevent damage to both the winch and the vehicle.

6. The power take-off lever should be returned to the disengaged position after winching operations are completed, to prevent the pump being driven unnecessarily when traveling along the road.

### Hydraulic winch maintenance

1. Every 40 operation hours check the oil level in the hydraulic oil supply tank. Oil should be just visible in the bottom of the oil filter.
2. Oil level in winch gearbox. Every 40 operation hours check the oil level by removing the level plug in the side of the end casing. Replenish as necessary, to the bottom of the level plug hole.

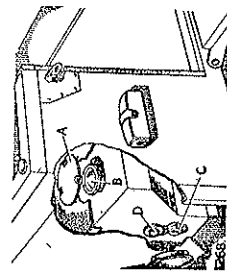

Supply tank for hydraulic winch, 'Regular' and 'Long' models illustrated

A—Cover plate  
B—Filler cap  
C—Drain plug  
D—Oil filter

Refill both supply tank and winch gear with oil of the correct grade.

### Capacity:

Supply tank: 4½ gallons (20,0 litres)

Winch gearbox: 2 pints (1,0 litre)

3. Oil changes. Every six months, drain off the oil from the supply tank by removing the slotted head drain plug. At the same time remove and clean the tank oil filter.

Also drain off the oil from the winch gearbox by removing the drain plug in the bottom of the casing.

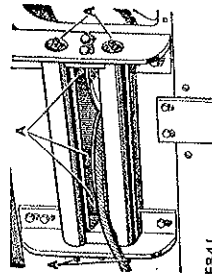

EB-41.

Lubrication nipples, Forward Control models

A—Grease nipples for rear guide wheels and rollers

## Optional equipment

4. Lubrication nipples. Every 40 operation hours apply one of the recommended grades of grease to the lubrication nipples at the following points:—

### Front winch installation:

Cable roller guides (6)

Drum bearings (2)

### Forward Control installation:

Rope retaining roller (1)

Rope guide wheels (3)

Rear rollers (2)

Front guide rollers (4)

Drum bearings (2)

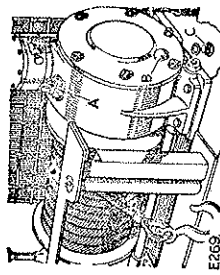

EB-39.

Hydraulic winch gearbox, 'Regular' and 'Long' models  
A—Filler plug  
B—Level plug  
C—Drain plug

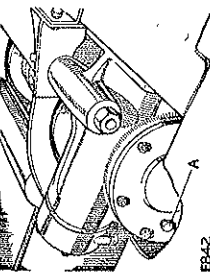

EB-42.

Hydraulic winch gearbox, Forward Control models  
A—Filler/level plug

At the same time, lubricate with oil, the drum shaft and control lever and, on Forward Control models, the control rod relays (2).

The drum lubrication nipples are accessible after paying out the winch cable.

### Capstan winch, 'Regular', 'Long' and Station Wagon

The front capstan winch, designed for a maximum pull of 2,500 lb. (1,135 kg.), is mounted on the front bumper and driven directly from the engine crankshaft.

The winch must be used with the engine running at 600 R.P.M., i.e., a fast idling speed and for this purpose a hand throttle control must also be fitted.

It is used with one end of the rope attached to the vehicle being pulled, then wound twice round the bollard, and with the winch drive engaged, the operator maintains a steady pull on the free end of the rope, thus causing it to grip the bollard.

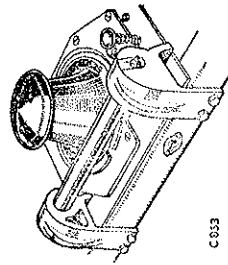

C-333

Front capstan winch

## Optional equipment

The most suitable rope size and type is 1¼ in. dia. (31,5 mm dia.), 3¾ in. (100 mm) circumference Manila.

Rope speed is 12½ ft./min. (4 metres/min.) at 600 engine R.P.M.

The drive should be engaged or disengaged by means of the operating knob on the winch casing, with the engine stationary and without any load on the rope.

With the winch installed, provision is made for the engine starting handle to be applied at the front of the winch instead of at the dog on the crankshaft.

### Capstan winch maintenance

1. Oil level. Every 40 operation hours, check the oil level by means of the dipstick incorporated in the filler plug and replenish as necessary.
2. Oil changes. Every six months, drain off the oil through the drain plug in the bottom of the winch casing and refill with oil of the correct grade; the capacity is 3½ Imperial pints (2 litres).
3. Lubrication nipple. Access to the lubrication nipple on the bollard shaft is gained by turning the bollard until the hole is in line with the nipple. Lubricate this point at intervals of 40 operation hours.

In addition, lubrication nipples are provided on the drive shaft and rope guide. Access to the drive shaft nipple may be gained from beneath the vehicle. Lubricate these points occasionally.

### Trailer

A two-wheeled trailer has been specially designed for use with all Land-Rover models except Forward Control. Its normal capacity is 1,680 lb. (760 kg.), but, over exceptionally rough ground, the load should be restricted to 1,340 lb. (650 kg.).

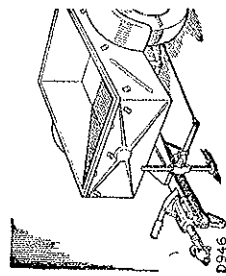

Trailer

A special towing ball which bolts

## Optional equipment

directly on to the rear chassis cross-member is supplied with the trailer. The towing ball-cup on the pull-pin is adjustable to allow wear on the towing ball to be taken up, so enabling a snug fit of the ball to be maintained at all times.

The pull-pin is interconnected with the brake linkage, so that when the vehicle brakes are applied and the trailer tends to overrun the towing vehicle, the trailer brakes are automatically applied. When reversing, a pivoted catch on the hand brake must be swung down to limit the pull-pin travel, to keep the brakes in the "off" position.

### Trailer maintenance

Every 1,000 miles (1,500 km) smear the towing ball and cup with grease, also check the grease in the hub bearing caps.

Occasionally oil brake rod linkage joints, etc.

### Brakes

Periodically adjust the brakes so that they commence to function when the pull-pin is pushed in 1 in. (25 mm).

### PART THREE IN CASE OF TROUBLE

#### Location and remedy of faults

Although every precaution is taken to eliminate all possible causes of trouble, failure may occasionally develop through lack of attention to the equipment, or damage to the wiring. The following pages set out the recommended procedure for a systematic examination to locate and remedy the causes of some of the more probable faults which may occur during the life of the vehicle.

All the checks listed can be readily carried out without special equipment; if the fault is not located in this way, consult the local Rover distributor or dealer, who will be able to investigate the defect more closely.

#### Engine fails to start, Petrol models

1. Check that the ignition is switched on.
2. Check that there is sufficient petrol in the tank.
3. Check that the cold start control is set correctly and, where fitted, carburettor starter heater element is functioning correctly, indicated by an additional 3-4 amps discharge on vehicle ammeter.
4. Check that the engine is being turned at an adequate speed by the starter motor; this speed will be recognised after some experience with the vehicle.

If the cranking speed is too low:—

- (i) Check the battery connections for tightness and cleanliness.
- (ii) Check the state of charge of the battery by switching on the headlamps and pressing the starter button; if the headlamps go out or very dim when the starter is operated, the battery requires recharging from an independent electrical supply.

It should be possible to start the engine by cranking with the starting handle.

A warning is given against the possibility of electric shock when handling the H.T. equipment. This danger will be eliminated by giving careful thought to the action anticipated, before carrying it out.

5. Remove and clean the sparking plugs and reset the electrode gaps to .029 to .032 in. (0.75 to 0.80 mm). Refit to engine; as plug covers are fitted an audible check should now be made.

(i) Lift the cover from each plug terminal in turn, about  $\frac{1}{4}$  in. (7 mm) and listen for the sharp snap of the spark, as the engine is turned over. Sparking should be strong and regular.

(ii) If the sparks are not regular:—

- (a) Check that the distributor rotor is in position.
- (b) Check that the L.T. connections on the coil and distributor are clean and tight.
- (c) Check that the distributor points are:—

1. Clean and opening and closing correctly.
2. Correctly set when open, gap .014 to .016 in. (0.35 to 0.40 mm).

(d) Check that current is present at the SW terminal on the coil, by disconnecting the wire at the coil end and touching it against the SW terminal, with the ignition switch on and the distributor contact-breaker points closed. If sparks occur, low tension current is flowing through the coil correctly; if there is no spark, either the coil or the low tension wiring is defective and your dealer should be consulted.

(iii) If the sparks are weak and in addition there is a flashing at the distributor contact breaker points, a faulty distributor condenser is indicated.

(iv) If the sparks are present on some leads, but not on others, check the distributor cap for cracks and the plug leads for faulty insulation.

### *In case of trouble*

6. Disconnect the petrol pipe from the carburetter and check that petrol is delivered to the carburetter when the hand lever on the petrol pump is operated. If petrol is not delivered from the pipe:—
- (i) Check that the petrol pipes and filters are clear.
  - (ii) Check that there are no air leaks in the suction line to the petrol pump.

#### **Engine starts but soon stops, Petrol models**

1. Check that the controls are set correctly.
2. Check the petrol feed to the carburetter.  
If there is little or no flow:—
  - (i) Check the petrol level in the tank.
  - (ii) Check that the air vent in the filler neck is clear.
  - (iii) Check the petrol pump for correct operation.
  - (iv) Check that the petrol filters are clear.
  - (v) Check that the petrol pipes are clear.
3. 4-cylinder models. Check that the carburetter jets are clear, in the following order:—
  - (i) Starter petrol jet; (ii) Main jet; (iii) Pilot jet.
4. Remove the carburetter top cover and check that there is no water in the float chamber.

#### **Engine misfires, Petrol models**

Engine not running on all cylinders, either intermittently or continually.

1. Stop the engine and endeavour to re-start with the starter motor to check the state of the battery and connections. If the battery is in a low state of charge, it will need recharging from an independent electrical supply, and the charging circuit should be checked as directed under charging circuit below.
- Before making the tests on the H. T. equipment you are advised to read the warning on page 103.

### *In case of trouble*

2. Remove the cover from each sparking plug in turn and check:
  - (i) By raising the cover from the plug terminal about  $\frac{1}{4}$  in. (7 mm) whilst engine is running. Sparks should be heard jumping the gap regularly.  
If no spark is present on one or more cylinders:—
    - (a) Remove and check the sparking plug concerned.
    - (b) Check for moisture on the H. T. leads or distributor.
    - (c) Check, clean and reset the distributor contact-breaker points to .014 to .016 in. (0.35 to 0.40 mm) as necessary.
    - (d) Check the distributor cap for cracks and the plug leads for faulty insulation.  
If the spark is irregular on all cylinders:—
      - (a) Check for moisture on H. T. leads or distributor.
      - (b) Check the distributor points, clean and re-set as necessary.
      - (c) Check the distributor cap for cracks and plug leads for faulty insulation.
      - (d) Check the L. T. connections for tightness and cleanliness.
      - (e) Check for flashing or "bluening" of the contact-breaker points. If present, the distributor condenser should be renewed.
      - (f) Check for a fault in the ignition circuit by connecting a wire between the "A" connection on the voltage regulator box and the "SW" connection on the coil, thus by-passing the ignition switch. At the same time, the wire from the ignition switch must be disconnected from the coil. Leave the ignition switch off.

**Note:** When making the above test remember that the "A" terminal is at battery potential. Connections to it must not be allowed to make contact with the metalwork of the vehicle otherwise a short circuit of the battery will result.

## *In case of trouble*

(ii) Listen for any audible alteration in the running of the engine, as each cover is lifted. No alteration will indicate that the sparking plug in question is at fault:—

(a) Remove and replace or clean the plug; reset the gap to .029 to .032 in. (0.75 to 0.80 mm) as necessary.

3. If the "missing" is accompanied by "spitting back" through the carburetter, a valve may be sticking. This can often be cured by slowly dropping thin oil or upper cylinder lubricant into the carburetter intake, while the engine is running. Persistence of this complaint points to the need for an engine overhaul.

### **Lack of engine power, Petrol models**

1. Check that the carburetter throttle is opening fully.
2. Check that the brakes are not binding and that the tyre pressures are correct.
3. 4-cylinder models. Check that the carburetter jets are not blocked, in the following order.
  - (i) Main jet; (ii) Pump jet; (iii) Economy jet.
4. Check the ignition timing.
5. Check the tappet adjustment.
6. If items 1-5 are satisfactory, it is probable that the engine needs decarbonising, and your Rover distributor or dealer should be consulted.

### **Starter motor, Petrol models**

1. Starter motor lacks power or fails to turn engine.
  - (a) Gearbox or power take-off auxiliary engaged.
  - (b) See if the engine can be turned over by hand. If not, the cause of the stiffness of the engine must be located and remedied.
  - (c) If the engine can be turned by hand, check that the trouble is not due to a discharged battery.
  - (d) Examine the connections to battery, starter and starter switch, making sure that they are tight and that the cables connecting these units are not damaged.

## *In case of trouble*

(e) It is also possible that the starter pinion may have jammed in mesh with the flywheel, although this is by no means a common occurrence. To disengage the pinion, pull off the dust cap and rotate the squared end of the starter shaft by means of a spanner.

2. Starter operates, but does not crank engine.

This fault will occur if the pinion of the starter drive is not allowed to move along the screwed sleeve into engagement with the flywheel, due to dirt having collected on the screwed sleeve. Clean the sleeve carefully with paraffin.

3. Starter pinion will not disengage from flywheel when engine is running.

Stop the engine and ascertain if the starter pinion is jammed in mesh with the flywheel. Release it, if necessary, by withdrawing the dust cap and rotating the squared end of the starter shaft in the opposite direction to normal rotation. If the pinion persists in sticking in mesh, have the equipment examined at a service depot. Serious damage may result to the starter if it is driven by the flywheel.

### **Engine will not crank by starter, Diesel models**

1. Gearbox or power take-off auxiliary engaged.
2. Battery terminals loose or broken or batteries discharged.
3. Switch wires and connections loose or broken or switch fault.
4. Starter or solenoid faulty.
5. Short circuit on heater plugs.

### **Engine will not crank, starter motor rotates, Diesel models**

1. Faulty starter clutch assembly.
- Engine will not crank on handle, Diesel models**
1. Gearbox or power take-off auxiliary engaged.
  2. Starter bendix jammed.
  3. Hydraulic lock. Water in combustion chamber. Check for internal water leaks.

*In case of trouble*

4. Hydraulic lock. Oil in combustion chamber.
5. Pump faulty. Must be repaired by a CAV Agent.

**Engine cranking speed low, Diesel models**

1. Battery terminals loose or broken or batteries discharged.
2. Earth connection, chassis to engine, broken or loose.
3. Wrong grade engine oil.
4. Starter faulty or short circuit on heater plugs.

**Sufficient engine cranking speed, Engine will not start, Diesel models**

1. Little or no fuel in tank. Replenish and prime system.
2. Stop control out or shut-off lever jammed. Linkage in-correctly adjusted.
3. Incorrect starting procedure.
4. Heater plugs faulty.
5. Throttle sticking or incorrectly adjusted.
6. Air in system due to fuel leaks on fuel pump, filter, injection pump or connection pipes. Rectify as necessary and prime system.
7. Insufficient flow of fuel at injection pump inlet.
8. Ample fuel at pump inlet but little or no fuel at injector pipes. Check that nylon or gauze filter at distributor pump inlet connection is not blocked or choked. If in doubt about pressure of fuel to injectors, remove injector and allow to spray in air. Keep well away from spray as fuel will penetrate the skin easily under these conditions. Ensure stop lever is in "run" position. If no injection, remove pump for checking, rectification or replacement.
9. Water in fuel system. Drain fuel system completely. Fit new paper filter element. It is advisable to remove injector pump for checking by a CAV Agent. After refitting pump, refill tank with clean fuel, prime fuel system.
10. Air vent at fuel tank restricted, causing vacuum.
11. Tank pick-up pipe blocked or fractured.
12. Incorrect pump timing or valve timing.

*In case of trouble*

13. Very low compression pressure due to faulty cylinder head gasket, piston rings or valves, etc.
14. Injectors or pump faulty. Pump must be repaired by a CAV Agent.

15. Aid to diagnosis of trouble, observe whether white smoke is emitted from exhaust. If no white smoke, fault is with injection equipment. If white smoke, fault is unlikely to be in injection equipment.

**Engine difficult to start, cranking speed sufficient, Diesel models**

1. Stop control out or shut-off lever jammed. Linkage in-correctly adjusted.
2. Incorrect starting procedure.
3. Heater plugs faulty.
4. Throttle sticking or incorrectly adjusted.
5. Faulty injectors.
6. Incorrect pump timing.
7. Leaking injector pipes.
8. Low compression pressures.
9. Pump faulty. Must be repaired by a CAV Agent.

**Engine starts but stops after a little running, requires priming to restart, Diesel models**

1. Little or no fuel in tank. Replenish and prime system.
2. Air in system due to fuel leaks on fuel pump, filter, injection pump or connection pipes. Rectify as necessary and prime system.
3. Insufficient flow of fuel at injection pump inlet.
4. Ample fuel at pump inlet but little or no fuel at injector pipes. Check that nylon or gauze filter at distributor pump inlet connection is not blocked or choked. If in doubt about pressure of fuel to injectors, remove injector and allow to spray in air. Keep well away from spray as fuel will penetrate the skin easily under these conditions. Ensure stop lever is in "run" position. If no injection, remove pump for checking, rectification or replacement.



*In case of trouble*

5. Air vent at fuel tank restricted, causing vacuum.
6. Tank pick-up pipe blocked or fractured.
7. Water in fuel. Drain and clean complete fuel system. Renew paper filter element. Drain and clean fuel storage tank. It is advisable to remove distributor pump for checking by a CAV Agent. After refitting pump, refill tank with clean fuel and prime fuel system. Ensure that dust and water is excluded to avoid recurrence of trouble.

**Engine stalls, Diesel models**

1. Engine operating temperature too low.
2. Idling stop incorrectly set. Reset to  $590 \pm 20$  r.p.m. with hand-brake on, while engine is hot. Must be carried out by Rover Distributor or Dealer.
3. Faulty injectors, incorrect pump timing, leaking injector pipes, faulty pump.
4. Excessive load, e.g., power take-off.
5. Internal collapse of air cleaner connection.

**Engine will not idle, Diesel models**

1. Hand or foot throttle linkage incorrectly set or jamming. Check with hand-brake on and off and adjust as necessary.
2. Idling stop incorrectly set.
3. Injectors or pump faulty. Pump must be repaired by a CAV Agent.

**Engine misfires, Diesel models**

1. Engine running on less than four cylinders, either intermittently or continually. Check injectors, rectify or replace. Check for leaks on high pressure pipes.
2. Check for blockage in spill pipe and connections.

**Lack of power, Diesel models**

1. Throttle linkage incorrectly set or jamming.
2. Excessive load on vehicle or power take-off; e.g., brakes binding.

*In case of trouble*

3. Faulty injectors or low compression pressures.
4. Maximum speed stop incorrectly set. Reset to  $4,000 \pm 20$  r.p.m. with engine hot. Must be carried out by a Rover Distributor or Dealer.
5. Pump faulty. Must be repaired by a CAV Agent.
6. Tappets incorrectly set. Reset inlet and exhaust tappets to .010 in. (0.25 mm) with engine hot or cold.
7. Petrol in fuel.

**Smoke, Diesel models**

1. Faulty injectors or incorrect pump timing.
2. Overfilled oil bath in air cleaner. Fill to correct level.
3. Choked air cleaner. Clean as maker's instructions.
4. Worn or faulty engine condition.
5. Pump faulty. Must be repaired by a CAV Agent.

**Charging circuit, all models**

1. Battery in low state of charge.
  - (a) This state will be shown by lack of power when starting. poor light from the lamps and hydrometer readings below 1.200, and may be due to the dynamo either not charging or giving low or intermittent output. Check the ammeter reading when the vehicle is running steadily in top gear with no lights in use; a definite steady charge should be indicated. The charging warning light will not go out if the dynamo fails to charge, or will flicker on and off in the event of intermittent output.
  - (b) Examine the charging and field circuit wiring, tightening any loose connections, or replacing broken cables. Pay particular attention to the battery connections.
  - (c) Examine the fan and dynamo driving belt; adjust tension as necessary.
  - (d) If the cause of the trouble is not apparent, have the equipment examined at a service depot

## 2. Battery overcharged.

This will be indicated by burnt-out bulbs, very frequent need for topping-up of battery and high hydrometer readings. Check the ammeter reading when the car is running steadily — with a fully charged battery and no lights or accessories in use, the charge reading should be of the order of only 3-4 amperes. If the ammeter reading is in excess of this value, it is advisable to have the regulator setting tested and adjusted if necessary at a service depot.

## Lighting circuits

## 1. Lamps give insufficient illumination.

- (a) Test the state of charge of the battery, recharging it if necessary either by a long period of day-time running or from an independent electrical supply.
- (b) Check the setting of the headlamps.
- (c) If the bulbs are discoloured as a result of long service, they should be renewed.

## 2. Lamps light when switched on, but gradually fade out.

Test the state of charge of the battery, recharging it if necessary either by a long period of day-time running or from an independent electrical supply.

## 3. Brilliance varies with speed of vehicle.

- (a) Test the state of charge of the battery, recharging it if necessary either by a long period of day-time running or from an independent electrical supply.
- (b) Examine the battery connections, making sure that they are tight; replace faulty cables.

## 4. Lights flicker.

Examine the circuits of the lamps for loose connections.

## 5. Failure of lights.

- (a) Test the state of charge of the battery, recharging it if necessary either by a long period of day-time running or from an independent electrical supply.
- (b) Examine the wiring for a loose or broken connection and remedy.

PART FOUR  
GENERAL DATA

Engine, 4-cylinder Petrol models	
Bore	90.49 mm (3.562 in.)
Stroke	88.9 mm (3.500 in.)
Number of cylinders	4
Cylinder capacity	2,286 c.c. (139.5 cu.in.)
Compression ratio	7.0-1
B.H.P.	77 at 4,250 r.p.m.
Maximum torque	124 lb.ft. (17 mkg.) at 2,500 r.p.m.
Firing order	1, 3, 4, 2
Spark plug type	Lodge CLN-H long reach - AC 46XL -
Spark plug point gap	.029 to .032 in. (0.75 to 0.80 mm)
Distributor contact breaker gap	0.0175 to 0.017
Ignition timing (static—full retard)	.014 to .016 in. (0.35 to 0.40 mm)
Ignition timing to be set to	3° B.T.D.C. Regular fuels 6° B.T.D.C. when Premium fuels are used
Tappet clearance, inlet	.010 in. (0.25 mm) } Engine
Tappet clearance, exhaust	.010 in. (0.25 mm) } at running temperature
Valve timing (No. 1 exhaust valve peak)	95° B.T.D.C.
Oil pressure	55 to 65 lb./sq.in. (3.8 to 4.6 kg./cm. <sup>2</sup> ) at 30 m.p.h. (50 k.p.h.) in top gear with engine warm
Lubrication	Full pressure
Oil filter, internal	Gauze pump intake filter in sump
Oil filter, external	Full-flow filter
Engine, 6-cylinder Petrol models	
Bore	3.063 in. (77.8 mm)
Stroke	3.625 in. (92.075 mm)
Number of cylinders	6
Cylinder capacity	160.3 cu.in. (2,625 c.c.)
Compression ratio	7.0-1
B.H.P.	90 at 4,500 r.p.m.

## General data

Maximum torque	....	132 lb./ft. (18 mkg.) at 1,500 r.p.m.
Firing order	....	1, 5, 3, 6, 2, 4
Spark plug	....	Lodge HBLN 14 mm with suppressors
Spark plug point gap	....	.029 to .032 in. (0,75 to 0,80 mm)
Distributor contact breaker gap	....	.014 to .016 in. (0,35 to 0,40 mm)
Ignition timing (static—full retard)	....	2° B.T.D.C. using Regular fuel, or 6° B.T.D.C. with Premium fuel
Tappet clearance, inlet	....	.006 in. (0,15 mm) } Engine at running temperature
Tappet clearance, exhaust	....	.010 in. (0,25 mm) }
Valve timing (No. 1 exhaust valve peak)	....	104° B.T.D.C.
Oil pressure	....	55 to 65 lb./sq.in. (3,8 to 4,6 kg./cm. <sup>2</sup> ) at 30 m.p.h. (50 k.p.h.) in top gear with engine warm
Lubrication	....	Full pressure
Oil filter, internal	....	Gauze pump intake filter in sump
Oil filter, external	....	Full-flow filter
<b>Engine, Diesel models</b>		
Bore	....	90,49 mm (3,562 in.)
Stroke	....	88,9 mm (3,500 in.)
Number of cylinders	....	4
Compression ratio	....	23-1
Cylinder capacity	....	2,286 c.c. (139,5 cu.in.)
B.H.P.	....	62 at 4,000 r.p.m.
Maximum torque	....	103 lb. ft. (14 mkg.) at 1,750 r.p.m.
Firing order	....	1, 3, 4, 2
Tappet clearance, inlet	....	.010 in. (0,25 mm) } Engine cold
Tappet clearance, exhaust	....	.010 in. (0,25 mm) } or at running temperature

## General data

Valve timing (No. 1 exhaust valve peak)	....	109° B.T.D.C.
Number of crankshaft bearings	....	3
Number of camshaft bearings	....	4
Vibration damper	....	Integral with fan driving pulley
Valve gear, inlet and exhaust	....	Overhead operated by roller followers, push rods and rockers
Oil pressure	....	50 to 60 lb./sq.in. (3,5 to 4,2 kg./cm. <sup>2</sup> ) at 30 m.p.h. (50 k.p.h.) in top gear with engine warm
Lubrication	....	Full pressure
Oil filter, internal	....	Gauze pump intake filter in sump
Oil filter, external	....	Full-flow filter
Mountings	....	Four-point rubber
<b>Clutch, 4-cylinder models</b>		
Type	....	Single dry plate 9 in. (230 mm) diameter. Hydraulic operation
Adjustment	....	Early models: 1½ in. (38 mm) free movement at pedal pad Late models: No adjustment is necessary on models with hydrostatic clutch
<b>Clutch, 6-cylinder models</b>		
Type	....	9½ in. (241 mm) diameter diaphragm type clutch. Hydraulic operation
Adjustment	....	Hydrostatic clutch. No adjustment necessary
<b>Main gearbox</b>		
Type	....	Single helical constant mesh with synchro-mesh on top and third speeds

General data

<b>Transfer box</b>	
Type ...	Two speed reduction on main gearbox output
<b>Front wheel drive</b>	Two/four wheel drive control on transfer box output
<b>Propeller shafts</b>	
Type ...	Open type to both axles
<b>Rear axle</b>	
Type ...	Spiral bevel; fully floating shafts
Ratio ...	4.7-1
<b>Front axle</b>	
Differential ...	Spiral bevel
Front wheel drive	Enclosed universal joints
Ratio ...	4.7-1

**Gear ratios, 'Regular', 'Long' and Station Wagon**

Main gearbox	Suffix letter 'A' and 'B' gearboxes		Suffix letter 'C' gearboxes
	Suffix letter 'A' gearboxes	Suffix letter 'B' gearboxes	
Top ...	Direct	Direct	Direct
Third ...	1.377-1	1.512-1	1.512-1
Second ...	2.043-1	2.22-1	2.22-1
First ...	2.996-1	3.6-1	3.6-1
Reverse ...	2.547-1	3.02-1	3.02-1
<b>Transfer gearbox</b>	Suffix letter 'A' and 'B' gearboxes		Suffix letter 'C' gearboxes
High transfer ...	1.148-1		1.148-1
Low transfer ...	2.888-1		2.4-1
Overall ratio (final drive)			
	In high transfer		In low transfer
	Suffix letter 'A' and 'B' gearboxes	Suffix letter 'C' gearboxes	Suffix letter 'C' gearboxes
Top ...	5.4-1	5.4-1	11.28-1
Third ...	7.4-1	8.15-1	17.0-1
Second ...	11.0-1	12.0-1	25.0-1
First ...	16.2-1	19.4-1	40.6-1
Reverse ...	13.77-1	16.3-1	34.0-1

General data

**Gear ratios. Forward Control models**

Main Gearbox	Suffix letter 'A' gearboxes		Suffix letter 'B' gearboxes
	Suffix letter 'A' gearboxes	Suffix letter 'B' gearboxes	
Top	Direct	Direct	Direct
Third	1.377-1	1.512-1	1.512-1
Second	2.043-1	2.22-1	2.22-1
First	2.996-1	3.6-1	3.6-1
Reverse	2.547-1	3.02-1	3.02-1
<b>Transfer gearbox</b>	Suffix letter 'A' gearboxes		Suffix letter 'B' gearboxes
High Transfer	1.3-1		1.53-1
Low Transfer	3.27-1		2.92-1
Overall ratio (final drive)			
	In High Transfer		In Low Transfer
	Suffix letter 'A'	Suffix letter 'B'	Suffix letter 'B'
Top	6.11-1	7.19-1	15.36-1
Third	8.414-1	10.86-1	21.164-1
Second	12.483-1	15.96-1	31.398-1
First	18.264-1	25.9-1	46.1-1
Reverse	15.56-1	21.7-1	39.147-1

**Fuel system, 4-cylinder Petrol models**

Petrol pump ...	Mechanical, with sediment bowl
Carburettor, basic ...	Solex PA10-5A downdraught type
Carburettor, with heater element ...	Solex PA10-6, downdraught type
Air cleaner ...	Oil bath type with integral centrifugal pre-cleaner

**Fuel system, 6-cylinder Petrol models**

Petrol pump ...	Dual electric, located at inside of right-hand sub-frame side-member
Carburettor ...	S.U. HD 6 single horizontal, dust-proof
Air cleaner ...	Oil bath type with integral centrifugal pre-cleaner.

## General data

<b>Fuel system, Diesel models</b>	
Fuel pump	Mechanical with hand primer (high pressure type)
Air cleaner	Oil bath type with integral centrifugal pre-cleaner
Fuel filters	Sediment bowl and gauze filter on mechanical fuel pump, CAV paper type filter
<b>Injection system, Diesel models</b>	
Injector pump	Distributor type, self-governing
Injectors: Type	CAV Pintaux
Start of injection	16° B.T.D.C.
<b>Cooling system</b>	
Type	Pump, fan and thermostat; pressurised to 9 lb./sq.in (0.6 kg/cm <sup>2</sup> )
<b>Electrical system, Petrol models</b>	
Type	Positive earth
Voltage	12
Battery capacity	57 A.H.
Ignition system	Coil
Charging circuit	Compensated voltage control
<b>Electrical system, Diesel models</b>	
Type	Positive earth
Voltage	12. Two 6 volt batteries in series
Battery capacity	120 A.H.
Charging circuit	Current-voltage control
<b>Replacement bulbs and units</b>	
<b>Headlamps with bulbs</b>	
R.H.D. except Sweden	Lucas 414, 12v., 50/40w.
R.H.D. Sweden only	Lucas 410, 12v., 45/40w, Duplo
L.H.D. Except North America and Europe	Lucas 415, 12v., 50/40w.

## General data

L.H.D. Europe except France	Lucas 410, 12v., 45/40w. Duplo
L.H.D. France	Lucas 411, 12v., 45/40w. Duplo yellow
<b>Headlamps with sealed beam units</b>	
R.H.D. except Sweden	Lucas 54521060
L.H.D. except Europe	Lucas 54520481
L.H.D. North America	Sealed beam unit, 12v.
Sidelamps	Lucas 207, 12v., 6w.
Stop, tail lamps	Lucas 380, 12v., 21/6w.
Flasher lamps	Lucas 382, 12v., 21w.
Rear number plate lamp	Lucas 989, 12v., 4w.
Instrument panel lights	Lucas 987, 12v., 2.2 MES
Warning lights	Lucas 987, 12v., ES2.2 M
<b>Suspension</b>	
Road springs	Semi-elliptic leaf
Hydraulic dampers	Telescopic; non-adjustable
<b>Brakes</b>	
Foot brake 88	Hydraulic, 10" brake drums
Foot brake 109	Hydraulic, 11" brake drums (Servo assisted on Forward Control models)
Hand brake	Mechanical on transfer box output shaft
<b>Steering</b>	
Recirculating ball	
Ratio	Basic models: Straight ahead ... 15.6-1 Full lock ... 23.8-1
<b>Forward Control models:</b>	
Straight ahead	... 19.6-1
Full lock	... 29.9-1
Front wheel toe-in	... $\frac{1}{8}$ to $\frac{1}{4}$ in. (1,3 to 2,4 mm)
Camber angle	... 1 $\frac{1}{2}$ °
Castor angle	... 3°
Swivel pin inclination	... 7°

Capacities	Imperial unit	U.S. unit	Litres
Engine sump oil, 4-cylinder	11 pints	13 pints	6,0
Engine sump oil, 6-cylinder	10 pints	12 pints	5,75
Extra when refilling after fitting new filter, 4-cylinder	* 3 pints	3½ pints	1,75
Extra when refilling after fitting new filter, 6-cylinder	1 pint	1.2 pints	0,5
Air cleaner, 4-cylinder	1½ pints	1.8 pints	0,85
Air cleaner oil, 6-cylinder	1 pint	1.2 pints	0,5
Main gearbox oil	2½ pints	3 pints	1,5
Transfer box oil	4½ pints	5½ pints	2,5
Front differential } basic	3 pints	3½ pints	1,75
Rear differential } type	3 pints	3½ pints	1,75
Front differential } ENV	2½ pints	2¾ pints	1,2
Rear differential } type	2½ pints	3.1 pints	1,4
Rear differential, limited slip type	3 pints	3½ pints	1,75
Swivel pin housing oil (each)	1 pint	1.2 pints	0,5
Fuel tank, except 109 Station Wagon and Forward Control	10 gallons	12 gallons	45
Fuel tank, 109 Station Wagon and Forward Control	16 gallons	19 gallons	73
Cooling system, Petrol models, except Forward Control	18 pints	21½ pints	10,25
Cooling system, Forward Control models, 4-cylinder	19 pints	22½ pints	10,8
Cooling system, Forward Control models, 6-cylinder	23 pints	27½ pints	13,0
Cooling system, Diesel models	17½ pints	21 pints	10,0
Hydraulic front winch, supply tank	4½ gallons	7½ gallons	20,0
Hydraulic front winch, gearbox	2 pints	2.4 pints	1,0

\*Late models: 2½ Imperial pints; 2½ U.S. pints; 1,5 litres

Recommended lubricants and fluids

These recommendations apply to temperate climates where operational temperatures may vary between approximately 10°F (-12°C) and 90°F (32°C).

Information on oil recommendations for use under extreme winter or tropical conditions can be obtained from your local Rover Distributor or Dealer or The Rover Company Limited, Technical Service Department.

Recommended lubricants and fluids

COMPONENTS	SAE	BP	CASTROL	DUCKHAM'S	ESSO	MOBIL	REGENT Texaco/Caltex	SHELL	Shell X-100	Advanced Havoline 20W	Rotella 20/20W	Spirax 90 EP	Universal Lubdan 90	Advanced 20/20W or Shell Tellus Oil 27	Retmax A
PETROL MODELS ENGINE AIR CLEANER AND GOVERNOR	20W	Energol SAE 20W	Castrolite	Duckham's NOL Twenty	Esso Motor Oil 20W/30	Mobilil Arctic	Advanced Havoline 20/20W	Shell X-100 20W	Advanced Havoline 20/20W	RPM Delo Special 20	Rotella 20/20W	Spirax 90 EP	Universal Lubdan 90	Shell X-100 20W or Shell Tellus Oil 27	Retmax A
DIESEL MODELS ENGINE AND AIR CLEANER	20W	Energol Diesel D20W	Castrol CR20	NOL Diesel Engine Oil 20	Essolet HD20	Mobilil Arctic	RPM Delo Special 20	Rotella 20/20W	Advanced Havoline 20/20W	RPM Delo Special 20	Rotella 20/20W	Spirax 90 EP	Universal Lubdan 90	Shell X-100 20W or Shell Tellus Oil 27	Retmax A
GEARBOX AND TRANSFER BOX															
*DIFFERENTIALS AND SWIVEL PIN HOUSINGS															
STEERING RELAY UNIT	90EP	Energol SAE 90EP	Castrol Hypov	Duckham's Hypoid 90	Esso Gear Oil GP 90/140	Mobilube GX 90	Universal Lubdan 90	Spirax 90 EP	Advanced 20/20W	Universal Lubdan 90	Spirax 90 EP	Universal Lubdan 90	Advanced 20/20W	Shell X-100 20W or Shell Tellus Oil 27	Retmax A
REAR POWER TAKE-OFF, PULLEY UNIT AND CAPSTAN WINCH															
HYDRAULIC WINCH															
GEARBOX															
HYDRAULIC WINCH SUPPLY TANK															
LUBRICATION NIPPLES															
BRAKE AND CLUTCH FLUID															
ANTI-FREEZE SOLUTION															

Any good quality glycol-base solution  
Girling 'Crimson' Brake and Clutch Fluid. Specification SAB 70 R 3.  
Shell Limited Slip Differential Oil S6721A or Mobilube 46—available in the UK market.  
Pure Oil TSS90, Texaco 3450 or Mobil 46—available in the North America Dollar area.  
\*Rear differential, limited slip type.

General data

Dimensions and Weights	Maximum approved pay load, normal roads		Maximum approved pay load, cross-country		Maximum drawbar pull, dependent upon surface conditions— Petrol models Diesel models		Internal body dimensions:		length (between capplings)		width (between capplings)		depth		height of wheel arch		width of wheel arch (to body side)		width of floor (between wheel arches)		height, floor to roof (maximum)		
	British	Metric	British	Metric	British	Metric	British	Metric	British	Metric	British	Metric	British	Metric	British	Metric	British	Metric	British	Metric	British	Metric	
88 Basic	4,000 lb.	1,800 kg.	3,330 lb.	1,497 kg.	4,000 lb.	1,800 kg.	800 lb.	363 kg.	43 in.	1,09 m	56½ in.	1,44 m	19½ in.	495 mm	8½ in.	216 mm	13½ in.	349 mm	36½ in.	921 mm	48½ in.	1,23 m	
	* Driver, two passengers and: 1,000 lb. 454 kg.																						
88 Station Wagon	100 lb.	45 kg.	50 lb.	23 kg.	1,800 kg.	1,497 kg.	50 lb.	23 kg.	72½ in.	1,85 m	56½ in.	1,44 m	19 in.	483 mm	9 in.	229 mm	13½ in.	349 mm	36½ in.	921 mm	48 in.	1,22 m	
	* Driver, two passengers and: 2,000 lb. 908 kg.																						
109 Basic	400 lb.	181 kg.	200 lb.	91 kg.	3,500 lb.	1,600 kg.	200 lb.	91 kg.	123½ in.††	3,14 m ††	63½ in.††	1,61 m ††	—	—	—	—	—	—	—	—	—	—	—
	Driver, two passengers and: 2,000 lb. 908 kg.																						
109 Station Wagon	3,380 lb.	1,532 kg.	2,800 lb.	1,270 kg.	3,500 lb.	1,600 kg.	2,900 lb.	1,315 kg.	—	—	—	—	—	—	—	—	—	—	—	—	—	—	
	Driver, two passengers and: 2,000 lb. 908 kg.																						
109 Forward Control	3,380 lb.	1,532 kg.	2,800 lb.	1,270 kg.	3,500 lb.	1,600 kg.	2,900 lb.	1,315 kg.	—	—	—	—	—	—	—	—	—	—	—	—	—	—	
	Driver, two passengers and: 2,000 lb. 908 kg.																						

† Maximum loads for cross-country when heavy duty springs are fitted.

†† Loading area.

General data

Dimensions and Weights	Overall length		Overall width		Overall unladen height, hood up		Overall unladen height, hood down, screen up		Overall unladen height, hood down, screen down		Overall unladen height, with cab or hard top		Wheelbase		Track		Turning circle		Unladen ground clearance under differentials, 6,00 x 16 tyres		Unladen ground clearance under differentials, 7,50 x 16 tyres		Unladen ground clearance under differentials, 9,00 x 16 tyres		Height, running, with water, oil, 5 gallons fuel:		Petrol models		Diesel models		
	British	Metric	British	Metric	British	Metric	British	Metric	British	Metric	British	Metric	British	Metric	British	Metric	British	Metric	British	Metric	British	Metric	British	Metric	British	Metric	British	Metric	British	Metric	
88 Basic	142½ in.	3,62 m	66 in.	1,68 m	77½ in.	1,97 m	68 in.	1,73 m	57½ in.	1,46 m	76½ in.	1,95 m	88 in.	2,23 m	51½ in.	1,31 m	38 ft.	11,6 m	203 mm	8½ in.	222 mm	8½ in.	222 mm	—	—	—	—	2,953 lb.	1,339 kg.	3,097 lb.	1,404 kg.
	* Driver, two passengers and: 1,428 lb. 648 kg.																														
88 Station Wagon	142½ in.	3,62 m	66 in.	1,68 m	77½ in.	1,97 m	68 in.	1,73 m	57½ in.	1,46 m	76½ in.	1,95 m	88 in.	2,23 m	51½ in.	1,31 m	38 ft.	11,6 m	203 mm	8½ in.	222 mm	8½ in.	222 mm	—	—	—	—	3,281 lb.	1,488 kg.	3,435 lb.	1,557 kg.
	* Driver, two passengers and: 1,428 lb. 648 kg.																														
109 Basic	175 in.	4,44 m	66 in.	1,68 m	77½ in.	1,97 m	68 in.	1,73 m	57½ in.	1,46 m	76½ in.	1,95 m	88 in.	2,23 m	51½ in.	1,31 m	47 ft.	14,3 m	248 mm	9½ in.	248 mm	9½ in.	248 mm	—	—	—	—	3,501 lb.	1,597 kg.	3,752 lb.	1,701 kg.
	* Driver, two passengers and: 2,000 lb. 908 kg.																														
109 Station Wagon	175 in.	4,44 m	66 in.	1,68 m	77½ in.	1,97 m	68 in.	1,73 m	57½ in.	1,46 m	76½ in.	1,95 m	88 in.	2,23 m	51½ in.	1,31 m	47 ft.	14,3 m	248 mm	9½ in.	248 mm	9½ in.	248 mm	—	—	—	—	3,752 lb.	1,701 kg.	4,200 lb.	1,904 kg.
	* Driver, two passengers and: 2,000 lb. 908 kg.																														
109 Forward Control	175 in.	4,44 m	66 in.	1,68 m	77½ in.	1,97 m	68 in.	1,73 m	57½ in.	1,46 m	76½ in.	1,95 m	88 in.	2,23 m	51½ in.	1,31 m	52 ft.	15,8 m	254 mm	10 in.	254 mm	10 in.	254 mm	—	—	—	—	4,200 lb.	1,904 kg.	—	—
	* Driver, two passengers and: 2,000 lb. 908 kg.																														

† With two exterior mirrors.



## INDEX

	Page
Additives, oil	44
Air cleaner	47
Ammeter	17
Anti-freeze mixture	35
Battery	68
Belt, fan and dynamo	57
Bleeding brake system	75
Bleeding clutch cylinder	62
Bonnet	31
Brakes	72
Brake adjustment	73
Brake and clutch fluid reservoir	60 and 73
Breather filters, engine	46
Brake servo unit	73
Bulbs	119
Capacities	120
Carburettor	52 and 55
Carburettor slow running	53
Changing gear	21
Charging warning light	14
Circuit diagrams	84
Cleaner, air	47
Cleaning carburettor filter	52
Cleaning carburettor jets	53
Clutch	60
Clutch adjustment, early type	61
Clutch mechanism, late type	15
Cold start control	16
Cold start control warning light	10
Controls	24
Control, front wheel drive	15
Control, cold start	35
Cooling system	46
Crankcase breather filter	113
Data	80
Diagram, circuit	70
Differential lubrication	122
Dimensions	18
Dipper switch	55
Distributor, Petrol models	67
Distributor pump, Diesel models	59
Drain plug, flywheel housing	70
Driving member, front and rear axle	58
Dynamo	68
Electrical equipment	11
Electrical services switch, Diesel models	63
Electrical services, starter and heater, plug switch	13
Engine details	111
Engine governor, Petrol models	93
Engine lubrication	44
Engine, oil level	43
Engine serial number	7
Engine speed hand control, Diesel models	29
Engine stop control, Diesel models	14
Engine timing	51
Fan belt, adjustment	57
Fan drive shaft lubrication	78
Fault location	102
Filler, fuel	34
Filler, radiator	35
Filters, engine breather	46
Filters, oil	44
Fluid, brakes and clutch 60 and 73	73
Flywheel housing drain plug	59
Flywheel markings	51
Free service	30
Front wheel drive control	24
Front winch capstan	99
Frost precautions	35
Fuel and injection system, Diesel models	64
Fuel level gauge	17
Fuel filter, Diesel models	66
Fuel pump	64 and 66
Fuel system, priming, Diesel models	64
Fuel system, Petrol models	63
Fuse box	69
Gearbox lubrication	58
Gear changing instructions	21
Gear lever, main	23
Gear ratios	116
Governor, engine, Petrol models	94
Guarantee-Warranty	7
Hand brake	21
Hand brake adjustment	74
Headlamps	19
Headlamp beam setting	79
Headlamp dipper switch	18
Headlamp warning light	50
Heater plug, Diesel	50
Heater plug, starter and electrical services switch	13
Heater plug warning light	16
Hydraulic winch	95
Ignition switch	11
Ignition timing	56
In case of trouble	102
Injector, Diesel	48
Instruments	10
Instrument panel light switch	18
Lamp switch	17
Lead lamp socket	18
Level gauge, fuel	17
Lever, main gearbox	23
Lever, transfer box	23
Location of faults	102
Lubricants recommended	39, 40 and 121
Lubrication	37
Lubrication, differentials	70
Lubrication, engine	43
Lubrication, main gearbox	58
Lubrication, propeller shafts	78
Lubrication, steering box	71
Lubrication, swivel pin housings	71
Lubrication, transfer box	58
Maintenance diagram	42
Number plate lamp	21
Octane selector	56
Oil additives	44
Oil cooler	93
Oil filters	44
Oil pressure	12
Oil pressure warning light	14
Optional equipment	90
Panel light switch	18
Petrol capacity	120
Petrol consumption	30
Petrol filler	34
Petrol pump	66
Power take-off units	91
Propeller shaft lubrication	78
Pulley, rear power take-off	93
Radiator filler	35
Ratios, gear	116
Rear drive pulley	93
Rear number plate lamp	21
Rear power take-off	92
Recommended lubricants	39, 40 and 121
Road springs	78
Routine maintenance	37
Running-in period	30
Seats, front	32
Sediment bowl	16
Serial numbers	63
Service organisation	7
Side lamps	20
Socket, lead lamp	18
Spare wheel	34
Sparking plugs	48
Specification	113
Springs, road	78
Starter and heater plug switch	12
Starter, electrical services and heater plug switch	13
Starter switch	12
Starting procedure	27 and 28
Steering ball joints	72
Steering box lubrication	71
Stop lamps	20
Switch, headlamp dipper	18
Switch, ignition	11
Switch, instrument panel light	18
Switch, lamp	17
Switch, starter	12
Switch, windscreen wiper	19
Swivel pin housing lubrication	71
Tail lamps	20
Tappet adjustment	50
Throttle hand control, Diesel models	29
Timing, engine	51
Timing, ignition	56
Tool storage	32
Trailer	100
Transfer box lever	23
Transfer box lubrication	58
Transmission brake adjustment	74
Trouble location	102
Tyre pressures	77
Vehicle dimensions	121
Vehicle serial number	7
Ventilators, windscreen	33
Warning light, headlamp	18
Warning light, charging	14
Warning light, cold start	16
Warning light, heater plug	16
Warning light, oil pressure	14
Warning light, fuel	16
Wheel brake adjustment	73
Wheel changing	76
Wheel, spare	34
Winch, capstan	99
Winch, hydraulic	95
Windscreen	33
Windscreen ventilators	33
Windscreen wiper	19

	Page
Heater plug warning light	16
Hydraulic winch	95
Ignition switch	11
Ignition timing	56
In case of trouble	102
Injector, Diesel	48
Instruments	10
Instrument panel light switch	18
Lamp switch	17
Lead lamp socket	18
Level gauge, fuel	17
Lever, main gearbox	23
Lever, transfer box	23
Location of faults	102
Lubricants recommended	39, 40 and 121
Lubrication	37
Lubrication, differentials	70
Lubrication, engine	43
Lubrication, main gearbox	58
Lubrication, propeller shafts	78
Lubrication, steering box	71
Lubrication, swivel pin housings	71
Lubrication, transfer box	58
Maintenance diagram	42
Number plate lamp	21
Octane selector	56
Oil additives	44
Oil cooler	93
Oil filters	44
Oil pressure	12
Oil pressure warning light	14
Optional equipment	90
Panel light switch	18
Petrol capacity	120
Petrol consumption	30
Petrol filler	34
Petrol pump	66
Power take-off units	91
Propeller shaft lubrication	78
Pulley, rear power take-off	93
Radiator filler	35
Ratios, gear	116
Rear drive pulley	93
Rear number plate lamp	21
Rear power take-off	92
Recommended lubricants	39, 40 and 121
Road springs	78
Routine maintenance	37
Running-in period	30
Seats, front	32
Sediment bowl	16
Serial numbers	63
Service organisation	7
Side lamps	20
Socket, lead lamp	18
Spare wheel	34
Sparking plugs	48
Specification	113
Springs, road	78
Starter and heater plug switch	12
Starter, electrical services and heater plug switch	13
Starter switch	12
Starting procedure	27 and 28
Steering ball joints	72
Steering box lubrication	71
Stop lamps	20
Switch, headlamp dipper	18
Switch, ignition	11
Switch, instrument panel light	18
Switch, lamp	17
Switch, starter	12
Switch, windscreen wiper	19
Swivel pin housing lubrication	71
Tail lamps	20
Tappet adjustment	50
Throttle hand control, Diesel models	29
Timing, engine	51
Timing, ignition	56
Tool storage	32
Trailer	100
Transfer box lever	23
Transfer box lubrication	58
Transmission brake adjustment	74
Trouble location	102
Tyre pressures	77
Vehicle dimensions	121
Vehicle serial number	7
Ventilators, windscreen	33
Warning light, headlamp	18
Warning light, charging	14
Warning light, cold start	16
Warning light, heater plug	16
Warning light, oil pressure	14
Warning light, fuel	16
Wheel brake adjustment	73
Wheel changing	76
Wheel, spare	34
Winch, capstan	99
Winch, hydraulic	95
Windscreen	33
Windscreen ventilators	33
Windscreen wiper	19

# LAND-ROVER Workshop Manual

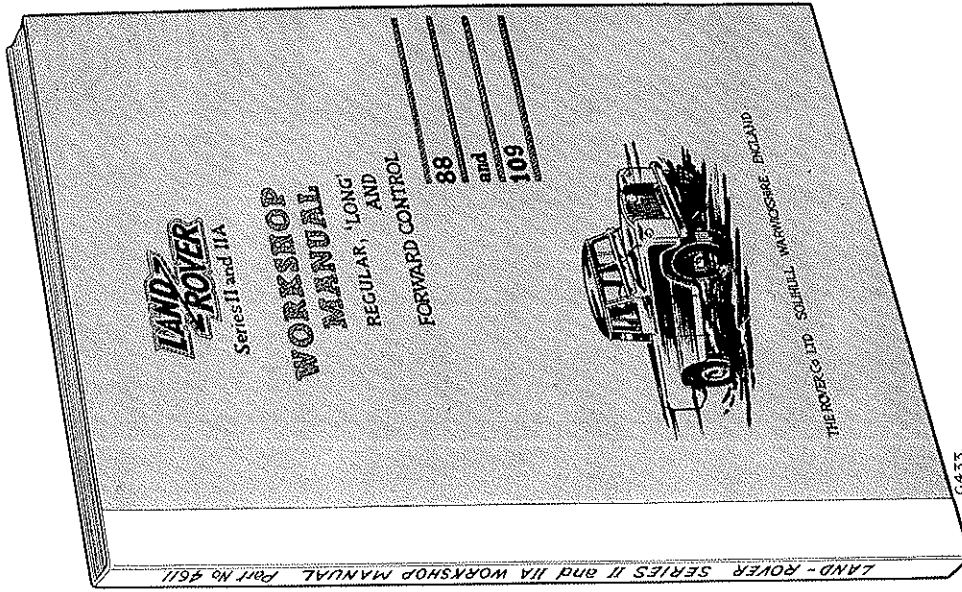

Containing practical information of the greatest value to everybody concerned with the maintenance and overhaul of the LAND-ROVER  
Copies can be obtained from all Rover Distributors and Dealers

**THE ROVER COMPANY LIMITED**  
Technical Service Department . . . . . Solihull, Warwickshire

PRINTED IN ENGLAND  
BY JOSEPH WONES LTD.,  
WEST BROMWICH, STAFFS.

42120